



Driver's Handbook
on Cargo Securement



A Guide to the North American Cargo Securement Standard

Preface

Disclaimers

This Handbook is based on the North American Cargo Securement Standard and is current as of November 2003. Federal, provincial, and state statutes may vary from the contents of this Handbook.



It is the responsibility of each organization to provide its personnel with specific personal safety training.

Table of Contents

- Introduction 1**
- 1. Fundamentals of Cargo Securement 3**
- 2. General Cargo Securement Requirements 8**
 - The Securement System 9
 - Components of a Securement System 10
 - Containing, Immobilizing, and Securing Cargo 15
 - Inspection Requirements 31
- 3. Logs 33**
- 4. Dressed Lumber and Similar Building Products 46**
- 5. Metal Coils 53**
- 6. Paper Rolls 66**
- 7. Concrete Pipe Loaded Crosswise 82**
- 8. Intermodal Containers 95**
- 9. Automobiles, Light Trucks, and Vans 100**
- 10. Heavy Vehicles, Equipment, and Machinery 103**
- 11. Flattened or Crushed Vehicles 107**
- 12. Roll-On/Roll-Off and Hook-Lift Containers 111**
- 13. Large Boulders 115**
- Appendix A: Default WLLs for Unmarked Tiedowns 123**
- Appendix B: Glossary 128**

Introduction



Introduction

Purpose of the Handbook

Learn how to:

- ◆ Apply the securement requirements in the North American Cargo Securement Standard.
- ◆ Safely load and secure specific types of commodities.
- ◆ Inspect a secured load for compliance with the North American Cargo Securement Standard.

If you follow the requirements in the North American Cargo Securement Standard, you will be in compliance with provincial (Canada) and Federal (US) regulations.

Local regulations may be more or less stringent.



The section references throughout this Handbook refer to particular sections of the North American Cargo Securement Standard.

How to Use the Handbook

1. For general cargo securement requirements, review:
 - ◆ Section 1: Fundamentals of Cargo Securement
 - ◆ Section 2: Cargo Securement Requirements
2. To correctly secure specific commodities, also review that section:
 - ◆ Section 3: Logs
 - ◆ Section 4: Dressed Lumber
 - ◆ Section 5: Metal Coils
 - ◆ Section 6: Paper Rolls
 - ◆ Section 7: Concrete Pipe
 - ◆ Section 8: Intermodal containers
 - ◆ Section 9: Automobiles, Light Trucks, and Vans
 - ◆ Section 10: Heavy Vehicles, Equipment, and Machinery
 - ◆ Section 11: Flattened or Crushed Vehicles
 - ◆ Section 12: Roll-On/Roll-Off and Hook Lift Containers
 - ◆ Section 13: Large Boulders

1. Fundamentals of Cargo Securement

Guiding Principle of Cargo Securement

What?

Cargo being transported on the highway must remain secured on or within the transporting vehicle.

When?

The cargo must remain secured on or in the transporting vehicle:

- ◆ Under all conditions that could reasonably be expected to occur in normal driving.
- ◆ When a driver is responding in all emergency situations, EXCEPT when there is a crash.

Why?



An improperly secured load can result in:

- ◆ Loss of life
- ◆ Loss of load
- ◆ Damage to the cargo
- ◆ Damage to the vehicle
- ◆ A crash
- ◆ Issuance of citations/fines to driver/carrier
- ◆ The vehicle being placed Out-of-Service.

1. Fundamentals of Cargo Securement

North American Cargo Securement Standard

What does the Standard cover? (Section 1.1)

Vehicles

- ◆ Commercial vehicles (including a combination of vehicles) that are operated on a highway and have a gross vehicle rating over 4,500 kg (10,000 lb.)



Gross Vehicle Rating = Greater Than 4,500 kg (10,000 lb.)

Cargo

- ◆ Any cargo and dangerous goods/hazardous materials, including:
 - All general freight.
 - All equipment carried for vehicle operation.
 - Intermodal containers and their contents.
- ◆ Some specific commodities have additional or different securement requirements (see later sections of this Handbook).
- ◆ Additional requirements under separate regulations may also apply for transportation of certain types of dangerous goods or hazardous materials.



It is assumed that heavy loads carried under special permits would be subject to securement standards contained in the special permit, which may differ from the North American Cargo Securement Standard. Check with your Federal, Provincial, or State government for any permit requirements.

1. Fundamentals of Cargo Securement

North American Cargo Securement Standard

What does the Standard require of the driver and carrier? (Section 2.3)

The following conditions must exist before a driver can operate a commercial motor vehicle and a carrier can require or permit a driver to operate a commercial motor vehicle.

- ✓ The commercial motor vehicle's cargo **must** be properly distributed and adequately secured.
- ✓ The commercial motor vehicle's structure and equipment **must** be secured:
 - Tailgate
 - Doors
 - Tarpaulins
 - Spare tire
 - Other equipment used in the vehicle's operation
 - Cargo securing equipment.

- ✓ The cargo or any other object must not:
 - Obscure the driver's view ahead or to the right or left sides (except for drivers of self-steer dollies).
 - Interfere with the free movement of the driver's arms or legs.
 - Prevent the driver's free and ready access to accessories required for emergencies. OR
 - Prevent the free and ready exit of any person from the commercial motor vehicle's cab or driver's compartment.



Inspections are addressed in a separate section. See Page 31.

1. Fundamentals of Cargo Securement

North American Cargo Securement Standard

What does the Standard require of the cargo? (Section 1.2)

Securement Options

All cargo must be contained, immobilized, or secured.

How Well Must Cargo be Secured?

So that it does not:

- ◆ Leak
- ◆ Spill
- ◆ Blow off the vehicle
- ◆ Fall from the vehicle
- ◆ Fall through the vehicle
- ◆ Otherwise become dislodged from the vehicle
- ◆ Shift upon or within the vehicle to such an extent that the vehicle's stability or maneuverability is adversely affected.



No rolling, tipping, sliding, or falling from vehicle.



There can be some movement if it doesn't reduce the effectiveness of the securement system.

1. Fundamentals of Cargo Securement

North American Cargo Securement Standard

How well must the securement system work? (Section 1.3)

Each cargo securement system must be able to withstand a minimum amount of force in each direction.

- ◆ **Forward Force** = 80% of cargo weight when braking while driving straight ahead.
- ◆ **Rearward Force** = 50% of cargo weight when accelerating, shifting gears while climbing a hill, or braking in reverse.
- ◆ **Sideways Force** = 50% of cargo weight when turning, changing lanes, or braking while turning.
- ◆ **Upward Force** = 20% of cargo weight when traveling over bumps in the road or cresting a hill.
 - This requirement is satisfied when the cargo is “Fully Contained.”

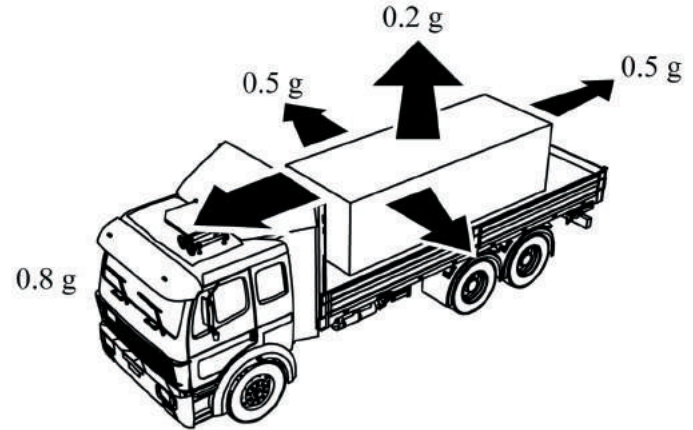

.5 g is 50% of force of gravity or 50% of cargo weight.

2. General Cargo Securement Requirements

- The Securement System p. 9
- Components of a Securement System
 - Vehicle structure p. 10
 - Securing devices p. 11
- Containing, Immobilizing, and Securing Cargo p. 15
 - Three ways to transport cargo p. 16
 - Loading the cargo properly p. 19
 - Restraining the cargo correctly p. 21
 - Using adequate securing devices p. 27
 - Aggregate Working Load Limit p. 29
- Inspection Requirements p. 31



2. General Cargo Securement Requirements

The Securement System

What is a securement system?

A securement system is a securement method that uses one or a combination of the following elements:

1. Vehicle Structure.
2. Securing Devices.
3. Blocking and Bracing Equipment.



What securement system should you choose? (Section 2.1.2)

The securement system chosen **must** be appropriate for the cargo's size, shape, strength, and characteristics.

Are there any requirements for the cargo? (Section 2.1.2)

The articles of cargo **must** have sufficient structural integrity to withstand the forces of loading, securement, and transportation.

This includes packaged articles, unitized articles, and articles stacked one on the other.

2. General Cargo Securement Requirements

Components of a Securement System

Vehicle structure (Section 2.1.1)

What is included?

- ◆ Floors
- ◆ Walls
- ◆ Decks
- ◆ Tiedown anchor points
- ◆ Headboards
- ◆ Bulkheads
- ◆ Stakes
- ◆ Posts
- ◆ Anchor points.



Generally, the cab shield is not part of the cargo securement system. However, a front-end structure could be used to provide some restraint against forward movement if the cargo is in contact with it.

How strong must the vehicle structure and anchor points be?

All elements of the vehicle structure and anchor points must be strong enough to withstand the forces described on page 7.

- ◆ Forward force: 0.8 g (80%)
- ◆ Rearward force: 0.5.g (50%)
- ◆ Sideways force: 0.5 g (50%)
- ◆ Upward force: 0.2 g (20%)

All elements of the vehicle structure and anchor points must be in good working order:

- ◆ No obvious damage.
- ◆ No distress.
- ◆ No weakened parts.
- ◆ No weakened sections.

2. General Cargo Securement Requirements

Components of a Securement System

Securing devices (Section 2.1.3)

What is a securing device?

Any device specifically manufactured to attach or secure cargo to a vehicle or trailer.

- ◆ Synthetic Webbing
- ◆ Chain
- ◆ Wire rope
- ◆ Manila rope
- ◆ Synthetic rope
- ◆ Steel strapping
- ◆ Clamps and latches
- ◆ Blocking
- ◆ Front-end structure
- ◆ Grab hooks
- ◆ Binders
- ◆ Shackles
- ◆ Winches
- ◆ Stake pockets
- ◆ D-rings
- ◆ Pocket
- ◆ Webbing ratchet
- ◆ Bracing
- ◆ Friction mat

What is a tiedown?

A combination of securing devices that forms an assembly that:

- ◆ Attaches cargo to, or restrains cargo on a vehicle.
- ◆ Is attached to anchor point(s).

Some tiedowns are attached to the cargo and provide direct resistance to restrain the cargo from movement.

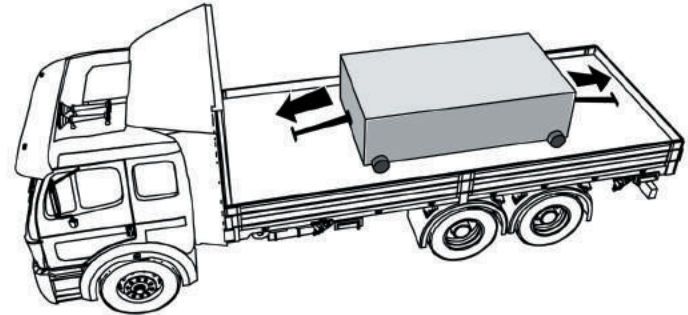

2. General Cargo Securement Requirements

Components of a Securement System

Securing devices (Section 2.1.3) (continued)

Some tiedowns pass over or through the cargo. They create a downward force that increases the effect of friction between the cargo and the deck. This friction restrains the cargo.

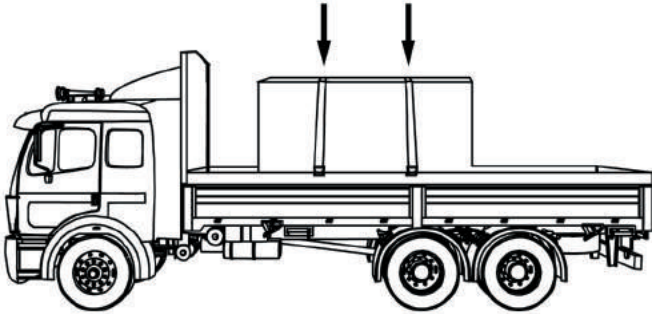

Tiedown passes over cargo

2. General Cargo Securement Requirements

Components of a Securement System

Securing devices (Section 2.1.3) (continued)

Tiedown construction and maintenance

A tiedown **must** be designed, constructed, and maintained so that the driver can tighten it (Exception: steel strapping).

All components of a tiedown **must** be in proper working order.

- ◆ No knots or obvious damage
- ◆ No distress
- ◆ No weakened parts
- ◆ No weakened sections

Tiedown use

Each tiedown **must** be attached and secured so that it does **not** become loose or unfastened, open, or release during transit.

All tiedowns and other components of a cargo securement system must be located within the rubrails (when present).



This requirement does not apply when the width of the load extends to or beyond the rubrails.



Tiedown within rubrail

2. General Cargo Securement Requirements

Components of a Securement System

Securing devices (Section 2.1.3) (continued)

Edge protection

Edge protection **must** be used if a tiedown could be cut or torn when touching an article of cargo. The edge protection itself **must** also resist crushing, cutting, and abrasion.

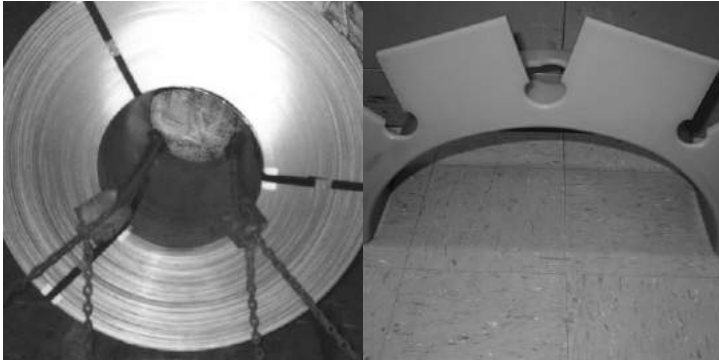

Use of edge protection

Edge protector

Blocking and bracing (Section 2.1.4)

Material used

The material used for blocking or bracing and as chocks and cradles **must** be strong enough to withstand being split or crushed by the cargo or tiedowns.

This requirement also applies to any material used for dunnage.

If wood is used:

- ◆ Hardwood is recommended.
- ◆ It should be properly seasoned.
- ◆ It should be free from rot or decay, knots, knotholes, and splits.

The grain should run lengthwise when using wood for blocking or bracing.

2. General Cargo Securement Requirements

Containing, Immobilizing, and Securing Cargo

To correctly contain, immobilize, or secure cargo, you need to know about:

- ◆ Three ways to transport cargo p. 16
- ◆ Loading the cargo properly p. 19
- ◆ Restraining the cargo correctly p. 21
- ◆ Using adequate securing devices p. 27
- ◆ Aggregate Working Load Limit p. 29

 These requirements cover all types of cargo except: Commodities in bulk that lack structure or fixed shape (for example, liquids, gases, grain, sand, gravel, aggregate, liquid concrete). Commodities that are transported in the structure of a commercial motor vehicle such as a tank, hopper, or box.

The Standard sets forth specific securement requirements for certain loads. When transporting these commodities, you **must** use the specific requirements for that commodity.

- ◆ Logs
- ◆ Dressed Lumber and Similar Building Products
- ◆ Metal Coils
- ◆ Paper Rolls
- ◆ Concrete Pipe Loaded Crosswise on a Platform Vehicle
- ◆ Intermodal containers
- ◆ Automobiles, Light Trucks, and Vans
- ◆ Heavy Vehicles, Equipment, and Machinery
- ◆ Flattened or Crushed Vehicles
- ◆ Roll-on/Roll-off and Hook-Lift Containers
- ◆ Large Boulders

2. General Cargo Securement Requirements

Containing, Immobilizing, and Securing Cargo

Three ways to transport cargo (Section 2.2.1)

All types of cargo **must** meet one of three conditions:

- ◆ Condition 1: Cargo is **fully contained** by structures of adequate strength.
 - Cargo cannot shift or tip
 - Cargo is restrained against horizontal movement by vehicle structure or by other cargo. Horizontal movement includes forward, rearward, and side to side.

If the cargo is contained in a sided vehicle, the vehicle structure **MUST** be strong enough to withstand the forces described on page 7.



- ◆ Forward force: 0.8 g (80%)
- ◆ Rearward force: 0.5.g (50%)
- ◆ Sideways force: 0.5 g (50%)

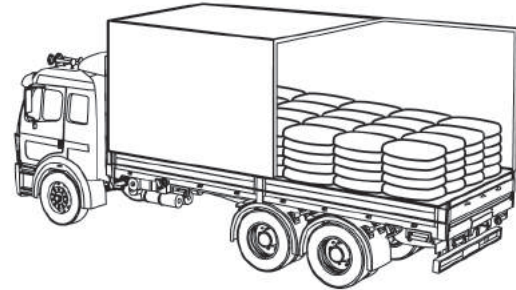

Fully contained

2. General Cargo Securement Requirements

Containing, Immobilizing, and Securing Cargo

Three ways to transport cargo (Section 2.2.1) (continued)

All types of cargo must meet one of three conditions:

- ◆ **Condition 2:** Cargo is **immobilized by structures** of adequate strength or a combination of structure, blocking, and bracing to prevent shifting or tipping.

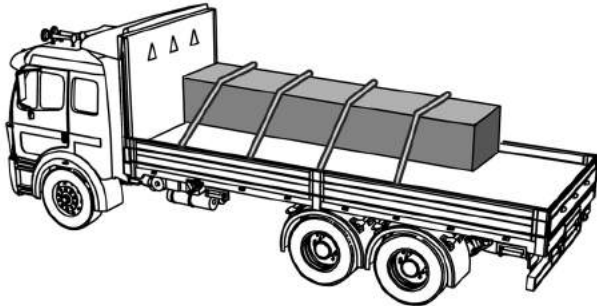

Immobilized

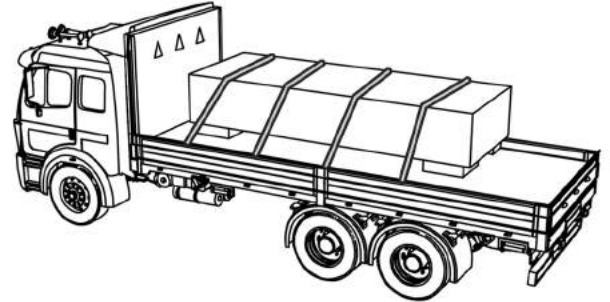

Immobilized

2. General Cargo Securement Requirements

Containing, Immobilizing, and Securing Cargo

Three ways to transport cargo (Section 2.2.1) (continued)

All types of cargo **must** meet one of three conditions:

- ◆ Condition 3: To prevent shifting or tipping, cargo is **immobilized or secured on or within** a vehicle by tiedowns along with:
 - Blocking.
 - Bracing.
 - Friction mats.
 - Other cargo.
 - Void fillers.
 - Combination of these.

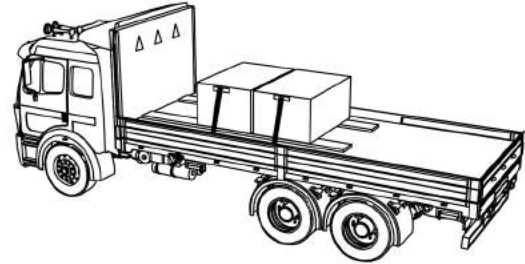

Secured on a vehicle

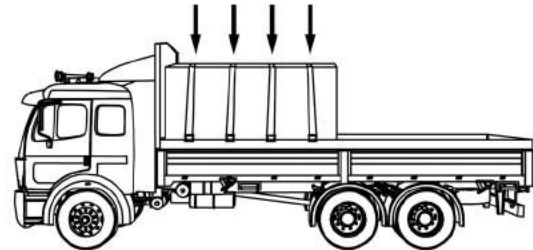

Secured on a vehicle

2. General Cargo Securement Requirements

Containing, Immobilizing, and Securing Cargo

Loading the cargo properly (Section 2.2.2)

For articles of cargo placed beside each other and secured by side-to-side tiedowns:

- ◆ Either place them in direct contact with each other
- ◆ Or prevent them from shifting towards each other in transit by using blocking or filling the space with other cargo.

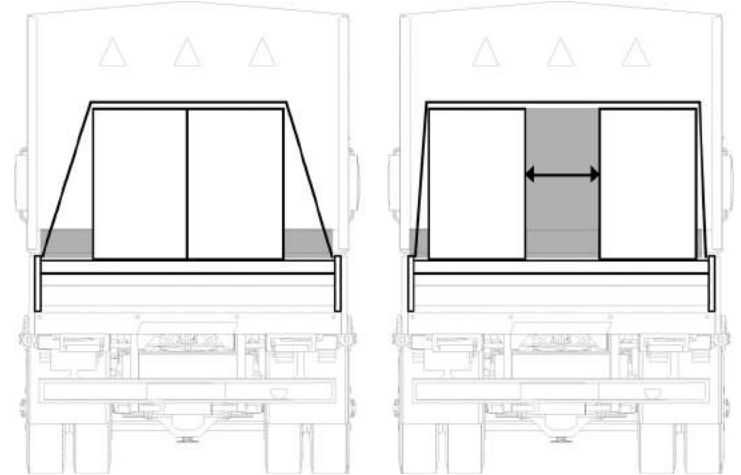

2. General Cargo Securement Requirements

Containing, Immobilizing, and Securing Cargo

Loading the cargo properly (Section 2.2.2) (continued)

Some articles have a tendency to roll. To prevent rolling, provide more than one point of contact:

- ◆ Lift the cargo off the deck AND/OR
- ◆ Place chockes, wedges, a cradle, or other equivalent means that prevent rolling. These **must** be secured to the deck.



The method used to prevent rolling must not become unfastened or loose while the vehicle is in transit.

For articles that have a tendency to tip:

- ◆ Prevent tipping or shifting by bracing the cargo.

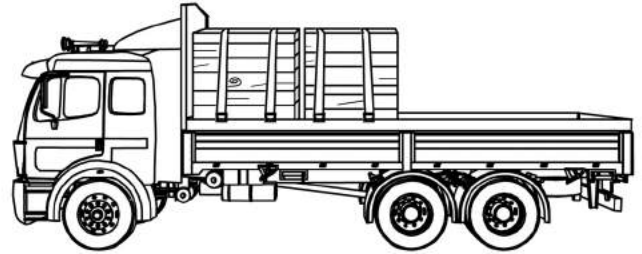

2. General Cargo Securement Requirements

Containing, Immobilizing, and Securing Cargo

Restraining the cargo correctly (Section 2.2.3.1)

How many tiedowns are required?

If cargo is **not prevented** from forward movement (for example, by the headboard, bulkhead, other cargo, or tiedown attached to the cargo), secure the cargo according to the following requirements:

Article Description	Minimum # of Tiedowns
◆ 1.52 m (5 ft) or shorter	1
◆ 500 kg (1,100 lb.) or lighter	

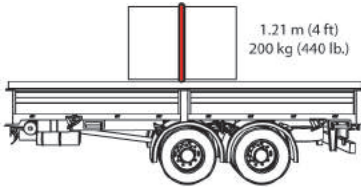

Article Description	Minimum # of Tiedowns
◆ 1.52 m (5 ft) or shorter	2
◆ Over 500 kg (1,100 lb.)	

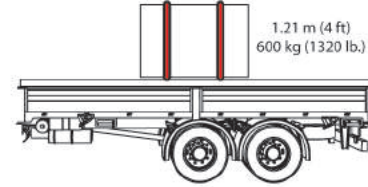

Article Description	Minimum # of Tiedowns
More than 1.52 m (5 ft) but 3.02 m (10 ft) or less	2

2. General Cargo Securement Requirements

Containing, Immobilizing, and Securing Cargo

Restraining the cargo correctly (Section 2.2.3.1) (continued)

Article Description	Minimum # of Tiedowns
Longer than 3.02 m (10 ft)	2 + 1 tiedown for every additional 3.02 m (10 ft), or part thereof

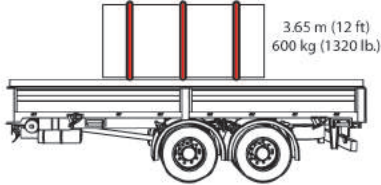

When cargo is prevented from forward movement (for example, by the headboard, bulkhead, other cargo, or tiedown), secure the cargo according to the following requirements:

Article Description	Minimum # of Tiedowns
All Cargo	1 tiedown for every 3.04 m (10 ft), or part thereof

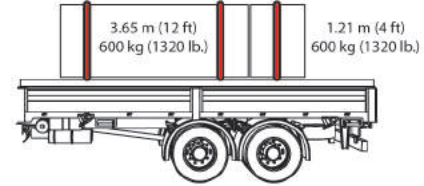

Exceptions to the Minimum Tiedown Requirements (Section 2.2.3.2)



A vehicle transporting one or more articles of cargo such as, but not limited to, machinery or fabricated structural items (e.g., steel or concrete beams, crane booms, girders, and trusses, etc.) which, because of their design, size, shape, or weight, must be fastened by special methods.

However, any article of cargo carried on that vehicle must be securely and adequately fastened to the vehicle.

2. General Cargo Securement Requirements

Containing, Immobilizing, and Securing Cargo

Restraining the cargo correctly (Section 2.2.3.1) (continued)

How should tiedowns be attached?

Tiedowns can be used in two ways:

- ◆ Attached to the cargo
 - Tiedowns attached to the vehicle and attached to the cargo.
 - Tiedowns attached to the vehicle, pass through or around an article of cargo, and then are attached to the vehicle again.
- ◆ Pass over the cargo
 - Tiedowns attached to the vehicle, passed over the cargo, and then attached to the vehicle again.

Tiedown placement

- ◆ Place the tiedown as close as possible to the spacer.
- ◆ Position the tiedowns as symmetrically as possible over the length of the article.

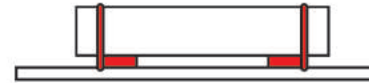

- ◆ Position the tiedowns to preserve the integrity of the article.

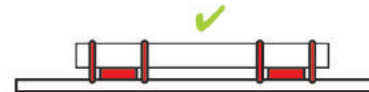
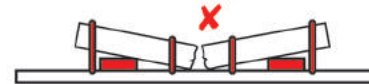

2. General Cargo Securement Requirements

Containing, Immobilizing, and Securing Cargo

Restraining the cargo correctly (Section 2.2.3.1) (continued)

Tiedowns attached to the cargo

Tiedowns attached to the cargo work by counteracting the forces acting on the cargo.

The angle where the tiedown attaches to the vehicle should be shallow, not deep (ideally less than 45°).



To counteract forward movement, attach the tiedown so it pulls the cargo toward the rear of the vehicle.

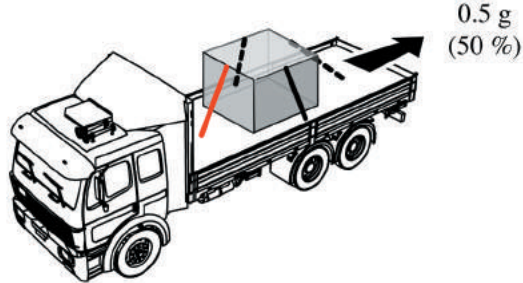

To counteract rearward movement, attach the tiedown so it pulls the cargo toward the front of the vehicle.

2. General Cargo Securement Requirements

Containing, Immobilizing, and Securing Cargo

Restraining the cargo correctly (Section 2.2.3.1)
(continued)

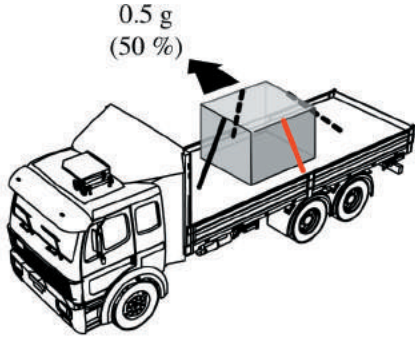

To counteract movement to one side, attach the tiedown so it pulls the cargo toward the opposite side of the vehicle.

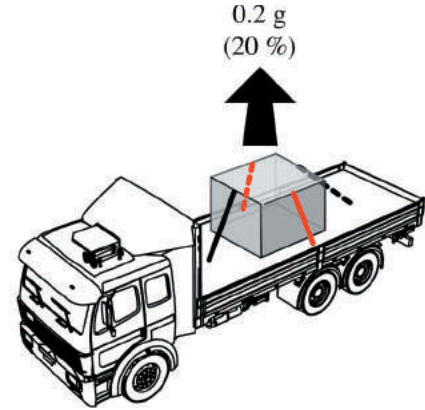

To counteract upward movement, attach tiedowns to opposing sides of the cargo so they pull the cargo down.

2. General Cargo Securement Requirements

Containing, Immobilizing, and Securing Cargo

Restraining the cargo correctly (Section 2.2.3.1) (continued)

Tiedowns that pass over the cargo

Tiedowns that pass over the cargo work by increasing the effective weight of the cargo (make the cargo seem heavier). This increases the pressure of the cargo on the deck and keeps the cargo from shifting.

Tension these tiedowns to as high an initial tension as possible.

The steeper the tiedown angle, the less shifting (ideally more than 45°).

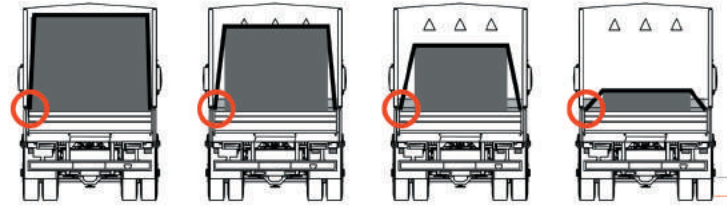

What should you use in low-friction situations?

When there is low friction between the cargo and the deck (for example, with snow, ice, sand, gravel, and oil):

- ◆ Use tiedowns attached to the cargo.
- ◆ Use a means to improve the friction such as friction mats or tiedown that pass over the cargo.
- ◆ Use blocking and tiedowns.

2. General Cargo Securement Requirements

Containing, Immobilizing, and Securing Cargo

Using adequate securing devices

What is a Working Load Limit (WLL)?

The Working Load Limit is the maximum load that may be applied to a component of a cargo securement system during normal service.

The WLL is usually assigned by the component manufacturer.



Indicator of Working Load Limit

WLL for tiedowns (Section 2.1.6)

The WLL for a tiedown is the lowest WLL of any of its parts or the WLL of the anchor points it is attached to, whichever is less. Every device contributes to the WLL of the securement system.

For a synthetic webbing tiedown, the WLL is the working load limit of the tiedown assembly or the anchor point it is attached to, whichever is less.



The minimum WLL requirement for the securement system is 50%. More tiedown capacity should be used if you need to secure an article against any movement.

WLL for blocking systems (Section 2.1.5)

The WLL of all components used to block cargo from forward movement must be 50% (or more) of the weight of the article being blocked.

2. General Cargo Securement Requirements

Containing, Immobilizing, and Securing Cargo Using adequate securing devices (continued)

Working Load Limits: marked components (Section 2.1.6)

Some manufacturers mark their manufactured securing devices with a numeric WLL value. The WLL for these devices is equal to the numeric value assigned by the manufacturer.

Other manufacturers mark components using a code or symbol that is defined in a recognized standard. For example:

A piece of grade 7 chain may be marked with a 70 or 700, in accordance with the standard of the National Association of Chain Manufacturers. The standard then gives the WLL for that piece of chain, depending on its size.

Working Load limits: unmarked components (Section 2.1.7)

Any securing device that is not marked by the manufacturer is considered to have a WLL as specified in Appendix A: Default WLLs for Unmarked Tiedowns.

Carriers are recommended to purchase and use components that are rated and marked by their manufacturer. In that way, the carrier, driver, shipper and inspector can all verify that the proper equipment is being used for the job.



Friction mats, which are not marked by the manufacturer, are assumed to provide a resistance to horizontal movement equal to 50% of the cargo weight that is resting on the mat.

2. General Cargo Securement Requirements

Containing, Immobilizing, and Securing Cargo

Aggregate Working Load Limit (Section 2.2.3)

What is the Aggregate Working Load Limit?

The sum of the working load limits of each device used to secure an article on a vehicle is called the aggregate working load limit.

How do you calculate Aggregate Working Load Limit for tiedowns?

To calculate Aggregate Working Load limit, add together:

- ◆ 50% of the WLL of each end section of a tiedown that is attached to an anchor point.
- ◆ 50% of the WLL of each end section that is attached to the cargo.

Example:

$$\begin{aligned} & 50\% \text{ of A} \\ + & 50\% \text{ of B} \\ + & 50\% \text{ of C} \\ + & 50\% \text{ of D} \\ + & 50\% \text{ of E} \\ + & 50\% \text{ of F} \\ + & 50\% \text{ of G} \\ + & 50\% \text{ of H} \\ \hline = & \text{Aggregate Working Load Limit} \end{aligned}$$

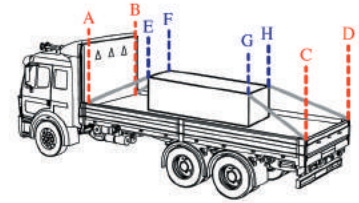

Example:

$$\begin{aligned} & 50\% \text{ of A} \\ + & 50\% \text{ of B} \\ + & 50\% \text{ of C} \\ + & 50\% \text{ of D} \\ \hline = & \text{Aggregate Working Load Limit} \end{aligned}$$

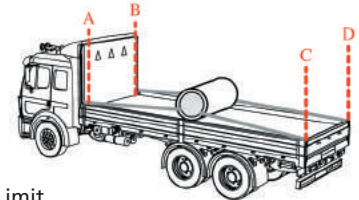

2. General Cargo Securement Requirements

Containing, Immobilizing, and Securing Cargo

Aggregate Working Load Limit (Section 2.2.3) (continued)

Example:

- 50% of A
- + 50% of B
- + 50% of C
- + 50% of D
- = Aggregate Working Load Limit

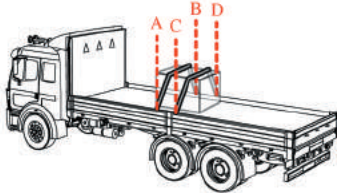

How much should the Aggregate Working Load Limit be?

The aggregate working load limit of any securement system must be **at least 50% of the weight of the cargo** being secured.



2. General Cargo Securement Requirements

Inspection Requirements (Section 2.3.2)

The driver is responsible for the following cargo securement inspection activities.

Driver action required	Pre-Trip	Within first 80 km (50 mi)	When duty status of driver changes	At 3 hour intervals or every 240 km (150 mi), whichever is first
Inspect Cargo and Securing devices	✓	✓	✓	✓
Inform Carrier if Packaging is Not Adequate	✓			
Adjust Cargo and/or Securing devices	As necessary	As necessary	As necessary	As necessary
Add Additional Securing devices	As necessary	As necessary	As necessary	As necessary

2. General Cargo Securement Requirements

Inspection Requirements (Section 2.3.2) (continued)



(Section 2.3.3) The inspection rules in 2.3.2 do not apply to the driver of a sealed commercial motor vehicle who has been ordered not to open it to inspect its cargo or to the driver of a commercial motor vehicle that has been loaded in a manner that makes inspection of its cargo impracticable.

Driver inspection checklist

Pre-Trip

- ◆ Make sure that cargo is properly distributed and adequately secured (in other words, according to the Standard).
- ◆ Make sure that all securement equipment and vehicle structures are in good working order and used consistent with their capability.
- ◆ Stow vehicle equipment.
- ◆ Make sure that nothing obscures front and side views or interferes with the ability to drive the vehicle or respond in an emergency.

- ◆ Inform carrier if packaging is not adequate. For example:
 - Banding is loose or not symmetrical on package.
 - Banding attachment device(s) are inefficient.
 - Wrapping is broken or ineffective.
 - Pallet are broken.

Periodic inspections during transit

- ◆ Inspect cargo and securing devices.
- ◆ Adjust cargo or load securement devices as necessary to ensure that cargo cannot shift on or within, or fall from, the commercial motor vehicle.
- ◆ As necessary, add more securing devices.

Law enforcement inspections

Law enforcement is responsible for roadside inspections in accordance with federal, state, or provincial laws.

3. Logs

- What Does This Section Cover?** p. 34
 - Components of the Securement System p. 37
 - Use of the Securement System..... p. 38
 - Vehicle Types p. 39
- Special Circumstances**
 - Securing Shortwood Logs
 - Loaded Crosswise on Frame, Rail, or Flatbed Vehicles..... p. 40
 - Securing Logs Loaded Lengthwise
 - on Flatbed and Frame Vehicles p. 43
 - Securing Logs Transported on Pole Trailers..... p. 45



3. Logs

What Does This Section Cover?

The standard defines a log as all natural wood that retains the original shape of the bole (trunk) of a tree whether raw, partiall processed, or fully processed.

- ◆ Raw: All tree species that have been harvested, with bark; may have been trimmed or cut to length
- ◆ Partially processed: Fully or partially debarked, or further reduced in length
- ◆ Fully processed: Utility poles, trated poles, log cabin building components

The specific requirements for logs cover shortwood and longwood.

Shortwood

- ◆ Normally up to about 2.5 m (100 in) in length.
- ◆ No longer than 4.9 m (16 ft) in length.
- ◆ Also called:
 - Cut-up logs
 - Cut-to-length logs
 - Bolts
 - Pulpwood.

Longwood

- ◆ Anything not considered shortwood.
- ◆ Also called:
 - Long logs
 - Treelength.

3. Logs

What Does This Section Cover? (continued)

Exceptions to the specific requirements (Section 3.1.1)

The following types of logs are not covered by the specific logs requirements:

- ◆ Logs unitized by banding or other comparable means.
[Secure according to general cargo securement requirements (Section 2).]
- ◆ Loads of no more than four processed logs.
[Secure according to general cargo securement requirements (Section 2).]
- ◆ Firewood, stumps, debris, other short logs, and longer logs.
[Transport in a vehicle or container enclosed on both sides, the front, and the rear and strong enough to contain them.]

3. Logs

What Does This Section Cover? (continued)

What's in a stack?

- ◆ Some stacks may be made up of both shortwood and longwood.
- ◆ Any stack that includes shortwood must follow the shortwood securement requirements.
 - **Exception:** If shortwood is embedded in load of longwood, it can be treated as longwood.



3. Logs

Components of the Securement System (Section 3.1.2)

Specially designed vehicle

Requirements

- ◆ Vehicle **must** be designed and built, or adapted, for transportation of logs.
- ◆ Vehicle **must** be fitted with a means to cradle the logs and prevent rolling, such as:
 - Bunks.
 - Bolsters.
 - Stakes. OR
 - Standards.
- ◆ All vehicle components must be designed and built to withstand all anticipated operational forces without failure, accidental release, or permanent deformation.

Stakes

Requirement

- ◆ If stakes or standards are not permanently attached to the vehicle, secure the stakes so that they do not separate from the vehicle.

Tiedowns

Requirements

- ◆ Use tiedowns in combination with bunks, stakes, or standards and bolsters to secure the load.
- ◆ All tiedowns must have a working load limit not less than 1,800 kg (4,000 lb.).
- ◆ Tension tiedowns as tightly as possible but not beyond their working load limit.

3. Logs

Use of the Securement System (Section 3.1.3)

Packing requirements

- ◆ **Requirement:** Logs must be solidly packed.
- ◆ **Requirement:** Outer bottom logs must be in contact with and rest solidly against bunks, bolsters, stakes, or standards.
- ◆ **Requirement:** Each outside log on the side of a stack of logs must touch at least two bunks, bolsters, stakes, or standards. If one end of the log doesn't touch a stake:
 - It must rest on other logs in a stable manner.
 - It must extend beyond the stake, bunk, bolster, or standard.
- ◆ **Requirement:** The center of the highest log on each side or end must be below the top of each stake, bunk, or standard.



Acceptable Packaging

- ◆ **Requirement:** There are two options for the upper logs that form the top of the load:
 - Either they must be crowned
 - Or each log that is not held in place by contact with other logs or stakes, bunks, or standards must be held in place by a tiedown.

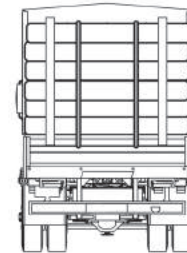

Acceptable placement of top logs

3. Logs

Use of the Securement System (Section 3.1.3) (continued)

Securement requirements

- ◆ Tighten tiedowns at initial loading.
 - Do not tension beyond the tiedown's working load limit.
- ◆ Check the load and tiedowns at entry onto a public road, in addition to the intervals specified on page x. Adjust load and tiedowns as needed.
- ◆ Use additional tiedowns or securing devices when there is low friction between logs and they are likely to slip on each other (for example, logs are wet or coated with sawdust).

Vehicle Types



Rail Vehicle

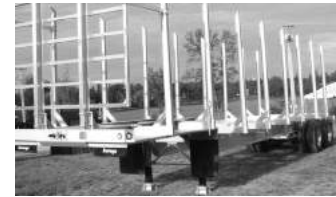

Frame Vehicle



Flatbed Vehicle

3. Logs

Special Circumstances: Securing Shortwood Logs Loaded Crosswise on Frame, Rail, and Flatbed Vehicles (Section 3.1.4)

Logs loaded crosswise on these vehicles must meet these requirements in addition to the other logs requirements on pages 38-39.

Lower tier requirements

- ◆ The end of a log in the lower tier must never extend more than 1/3 of the log's total length beyond the nearest supporting structure. This prevents tipping when the vehicle turns.

Tiedowns requirements

- ◆ Use two tiedowns to secure one stack of shortwood loaded crosswise.
 - Attach the tiedowns to the vehicle frame at the front and rear of the load.
- ◆ Position tiedowns approximately 1/3 and 2/3 of the length of the logs.

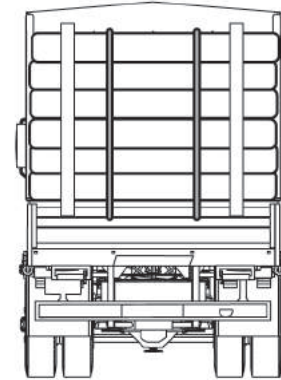

Acceptable securement of one stack loaded crosswise

3. Logs

Special Circumstances: Securing Shortwood Logs Loaded Crosswise on Frame, Rail, and Flatbed Vehicles (Section 3.1.4) (continued)

Requirements for dividing vehicles over 10 m (33 ft)

- ◆ Vehicles over 10 m (33 ft) must be equipped with center stakes, or comparable devices, to divide it into sections of equal length.
- ◆ Each tiedown **must**:
 - Secure the highest log on each side of the center stake.
 - Be fastened below these logs.
- ◆ Three securement options:

Option #1:

Tiedowns may be fixed at each end and tensioned from the middle.

Option #2:

Tiedowns may be fixed in the middle and tensioned from each end.

Option #3:

Tiedowns may pass through a pulley or equivalent device in the middle and tensioned from one end.

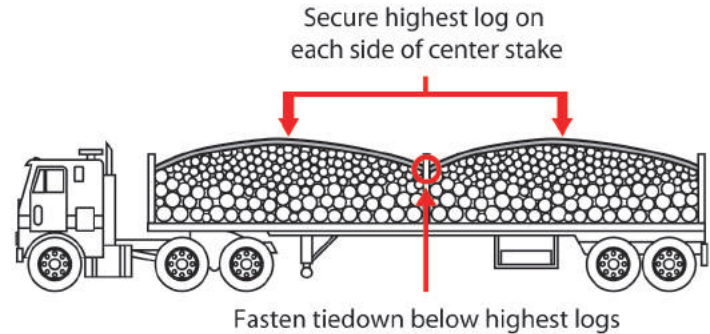

Crosswise stacks on divided vehicle over 10m (33 ft) long

3. Logs

Special Circumstances: Securing Shortwood Logs Loaded Crosswise on Frame, Rail, and Flatbed Vehicles (Section 3.1.4) (continued)

Stakes/structure and tiedowns requirements

Anchor any structure or stake that is being forced upward when the tiedowns are being tensioned.

Additional requirements securement for two stacks side-by-side

- ◆ In addition to the requirements for shortwood loaded crosswise, load two stacks side-by-side so that:
 - There is no space between the stacks of logs.
 - The outside of each stack is raised at least 2.5 cm (1 in) within 10 cm (4 in) of the end of the logs or from the side of the vehicle.
 - The highest log is no more than 2.44 m (8 ft) above the deck.
 - At least one tiedown is used lengthwise across each stack.

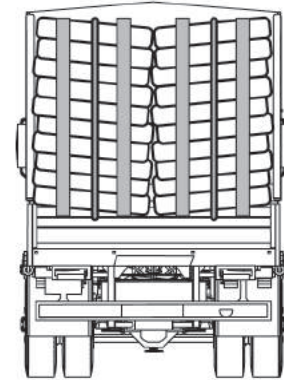

Acceptable securement of two stacks of shortwood logs loaded crosswise

3. Logs

Special Circumstances: Securing Logs Loaded Lengthwise on Flatbed and Frame Vehicles (Section 3.1.5)

Logs loaded lengthwise on these vehicles must meet these requirements in addition to the other logs requirements on pages 38-39.

Requirements for shortwood loaded lengthwise

- ◆ Shortwood **must** be cradled in a bunk or contained by stakes.
- ◆ Logs should be centered in the bunk.
- ◆ Each outside log bearing against stakes should extend at least 0.15 m (6 in) beyond the stakes at each end.

Shortwood and tiedowns requirements

Two tiedowns

- ◆ Secure each stack of shortwood with at least two tiedowns.

One tiedown

- ◆ A stack can be secured with one tiedown if all logs in the stack less than 3.04 m (10 ft) are:
 - Blocked in the front by a headboard strong enough to restrain the load or by another stack of logs.
 - Blocked in the rear by the vehicle's end structure or another stack of logs.
- ◆ Position the one tiedown about midway between bunks, stakes, or standards.

3. Logs

Special Circumstances: Securing Logs Loaded Lengthwise on Flatbed and Frame Vehicles (Section 3.1.5) (continued)

Requirements for securing longwood loaded lengthwise

- ◆ Longwood **must** be cradled in two or more bunks or contained by stakes.
- ◆ Each outside log should bear against at least two stakes, one near each end of the log.
- ◆ Each end of the log should extend at least 0.15 m (6 in) beyond the stakes.
- ◆ If shorter logs are carried on top of the stack, secure each log with at least two tiedowns.

Longwood and tiedown requirements

- ◆ Secure each stack of longwood with at least two tiedowns at positions along the load that provide effective securement.
- ◆ Secure each outside log of a stack with at least two tiedowns.

Working load limit for longwood and shortwood loaded lengthwise

The aggregate working load limit for all tiedowns must be no less than 1/6 the weight of the stack of logs.



This requirement is much less than the general requirement of an aggregate working load limit equal to ½ the weight of the load. This lowered requirement recognizes that the bunks/ stakes help to prevent slippage.

3. Logs

Special Circumstances: Securing Logs Transported on Pole Trailers (Section 3.1.6)

Requirements for logs on pole trailers

- ◆ Secure the load in one of these ways:
 - Either at least one tiedown at each bunk.
 - Or at least two tiedowns used as wrappers that encircle the entire load.

Wrapper requirements

- ◆ Position front and rear wrappers at least 3.04 m (10 ft) apart.

Large logs – shift prevention requirement

- ◆ Use chock blocks to prevent the shifting of large diameter single and double log loads.

Large logs – additional tiedowns requirement

- ◆ Secure large diameter logs that are above the bunks to the underlying load with at least two additional wrappers.



4. Dressed Lumber and Similar Building Materials

What Does This Section Cover? p. 47
Positioning and Securing Bundles p. 48



4. Dressed Lumber and Similar Building Materials

What Does This Section Cover? (Section 3.2.1)

The requirements for dressed lumber and similar building materials section apply to certain products when they are transported as bundles on flatbed and open vehicles.

These products are:

- ◆ Dressed lumber.
- ◆ Packaged lumber.
- ◆ Engineered building products (e.g. plywood, drywall, other materials of similar shape).



Lumber or building products that are not bundled or packaged should be treated as loose items and transported in accordance with the general cargo securement requirements in Section 2.



Bundles carried in a closed vehicle should be immobilized or contained in accordance with the general cargo securement requirements in Section 2.

4. Dressed Lumber and Similar Building Materials

Positioning and Securing Bundles (Section 3.2.2)

Requirements for bundles placed side by side on a platform vehicle

Choose one of two options for positioning bundles:

Option #1:

Place bundles in direct contact with each other.

Option #2:

Provide a means (such as dunnage or blocking) to prevent the bundles from shifting towards each other.

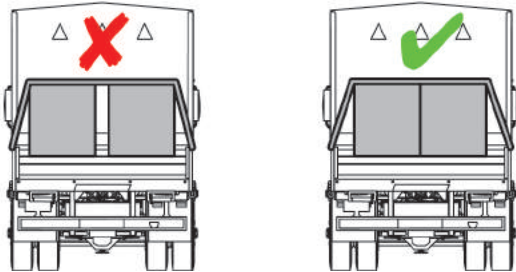

Requirements for bundles in one tier

- ◆ Secure bundles in accordance with general cargo securement requirements (Section 2).
- ◆ Web tiedowns are often used to secure building materials.

Requirements for Securement System:

- ◆ In proper working order with no damaged or weakened components that affect their performance or reduce their working load limit.
- ◆ No knots.
- ◆ Attached and secured in a manner that prevents them from coming loose during transit.
- ◆ Able to be tightened by a driver of an in-transit vehicle.
- ◆ Located inboard of rub rails whenever practicable.
- ◆ Edge protection must be used when a tiedown would be subject to abrasion or cutting.



4. Dressed Lumber and Similar Building Materials

Positioning and Securing Bundles (Section 3.2.2) (continued)

Requirements for securing bundles in two or more tiers

There are four options for securing bundles of dressed lumber that are transported in two or more tiers. Choose one of the four.

Option #1:

To block side-to-side movement, block the bundles with stakes on the sides of the vehicle. Secure the bundles by tiedowns laid out over the top tier, as outlined in Section 2.

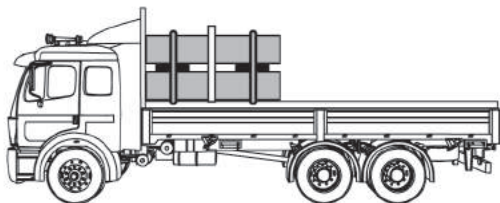

Requirements for bundles in two or more tiers (continued)

Option #2:

To block side-to-side movement, use blocking or high friction devices between the tiers. Secure the bundles by tiedowns laid out over the top tier, as outlined in Section 2.

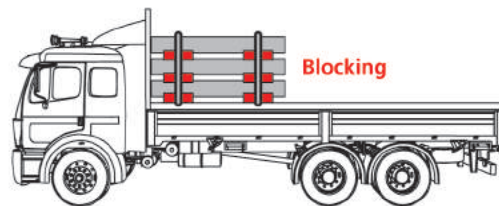

4. Dressed Lumber and Similar Building Materials

Positioning and Securing Bundles (Section 3.2.2) (continued)

Requirements for bundles in two or more tiers (continued)

High Friction Devices



- ◆ Friction mat
- ◆ Piece of wood with friction surface
- ◆ Cleated mat
- ◆ Other specialized equipment

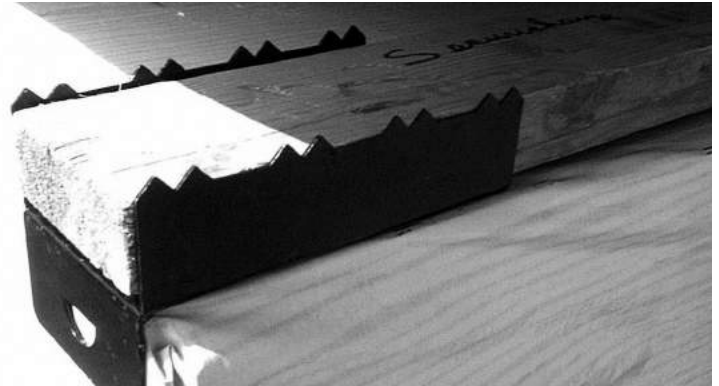

4. Dressed Lumber and Similar Building Materials

Positioning and Securing Bundles (Section 3.2.2) (continued)

Requirements for bundles in two or more tiers (continued)

Option #3:

Place bundles directly on top of other bundles or on spacers.

Secure the stack of bundles with tiedowns:

- ◆ Tiedowns over the second tier of bundles or at 1.85 m (6 ft) above the trailer deck (whichever is greater).
- ◆ Tiedowns for other multiple tiers not over 1.85 m (6 ft) above the trailer.
- ◆ Tiedowns over the top tier of bundles with a minimum of 2 tiedowns over each top bundle longer than 1.52 m (5 ft).

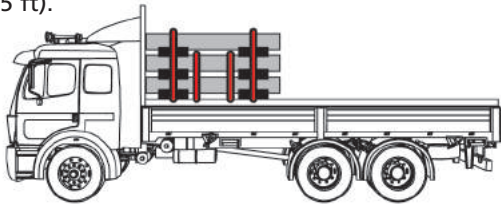

Spacer Requirements



- ◆ The length of spacers **must** provide support to all pieces in the bottom row of the bundle.
- ◆ The width of each spacer **must** be equal or greater than the height.
- ◆ Spacers **must** provide good interlayer friction.
- ◆ If spacers are comprised of layers of material, the layers **must** be unitized or fastened together to ensure that the spacer performs as a single piece of material.

4. Dressed Lumber and Similar Building Materials

Positioning and Securing Bundles (Section 3.2.2) (continued)

Bundles in Two or More Tiers (continued)

Option #4:

- ◆ Secure the bundles by tiedowns over each tier of bundles in accordance with the general cargo securement requirements (Section 2).
- ◆ Use at least 2 tiedowns over each bundle on the top tier that is longer than 1.52 m (5 ft).

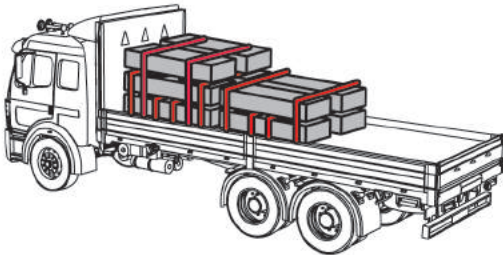

Suggestion to Increase Safety

Choose one of two options for stopping forward motion:

Option #1:

Place bundles against bulkhead/front end structure.

Option #2:

When different tiers need to be secured, use a combination of blocking equipment and tiedowns.

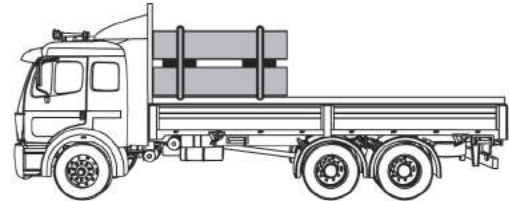

5. Metal Coils

- What Does This Section Cover? p. 54
- Securing Coils
 - Transported With Eyes
 - Vertical on a Vehicle With Anchor Points p. 55
 - Transported With Eyes
 - Crosswise on a Vehicle With Anchor Points p. 57
 - Transported With Eyes
 - Lengthwise on a Vehicle With Anchor Points p. 60
 - Transported in a Sided Vehicle
 - or Intermodal Container Without Anchor Points p. 65



5. Metal Coils

What Does This Section Cover?

This section applies to coils of rolled sheet metal. Coiled wire is secured using the general cargo securement requirements (section 2).

Size of coil (Section 3.3.1)

- ◆ All metal coil shipments that, individually or together, weigh 2,268 kg (5,000 lb.) or more must be secured according to the specific requirements in this section.
- ◆ Exception: Metal coils that weigh less than 2,268 kg (5,000 lb.) may be secured according to general securement requirements (Section 2).

Orientation of coil

- ◆ Eyes vertical

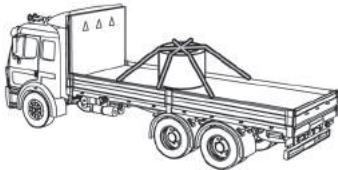

- ◆ Eyes crosswise

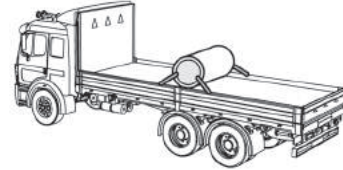

- ◆ Eyes lengthwise

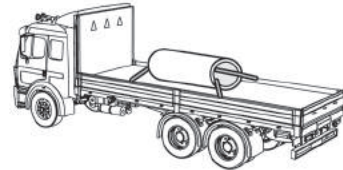

Type of Vehicle

The specific requirements are for metal coils transported:

- ◆ On flatbed vehicles.
- ◆ In sided vehicles with or without anchor points.
- ◆ In intermodal containers with or without anchor points.

5. Metal Coils

Securing Coils Transported With Eyes Vertical on a Vehicle with Anchor Points (Section 3.3.2)

If the coil is mounted on a pallet:

- ◆ Coil **must** be fastened to pallet so it cannot move on the pallet.
- ◆ Pallet **must** be strong enough to not collapse under Performance Criteria forces (Section 1).
- ◆ Use a friction mat between pallet and deck.

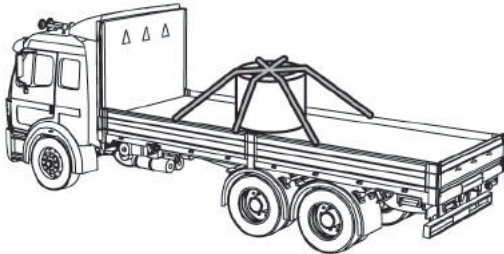

Requirementst for securing a single coil (Section 3.3.2.1)

- ◆ To prevent the coil from tipping forward, rearward, and sideways, arrange tiedowns to include the following:
 - Attach at least one tiedown diagonally across eye of coil from left side of vehicle to right side of vehicle.
 - Attach at least one tiedown diagonally across eye of coil from right side of vehicle to left side of vehicle.
 - Attach at least one tiedown over eye of coil from side-to-side.
- ◆ To prevent forward movement, use one of these:
 - Blocking.
 - Bracing.
 - Friction mats.
 - A tiedown passed around the front of coil.

5. Metal Coils

Securing Coils Transported With Eyes Vertical on a Vehicle with Anchor Points (continued)

Requirements for securing a row of coils (Section 3.3.2.2)

- ◆ Attach at least one tiedown against front of row of coils to restrain against forward motion.
 - If possible, angle between tiedown and deck should be less than 45° , when viewed from the side of the vehicle.
- ◆ Attach at least one tiedown against rear of row of coils to restrain against rearward motion.
 - If possible, angle between tiedown and deck should be less than 45° , when viewed from the side of the vehicle.

- ◆ Attach at least one tiedown over top of each coil or side-by-side row of coils to restrain against vertical motion.
 - Tiedowns going over top of coil(s) must be as close as possible to eye of coil.
- ◆ Arrange tiedowns, blocking, or bracing to prevent shifting or tipping in all directions.

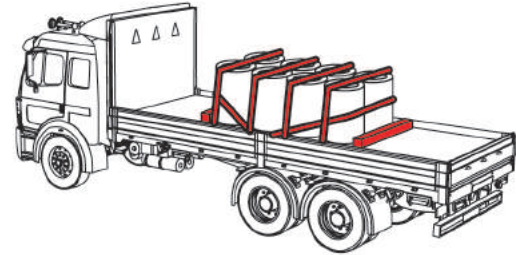

5. Metal Coils

Securing Coils Transported With Eyes Crosswise on a Vehicle with Anchor Points (Section 3.3.3)

There are three requirements for coils transported with eyes crosswise:

1. Prevent the coil from rolling.
2. Attach one tiedown forward.
3. Attach one tiedown rearward.

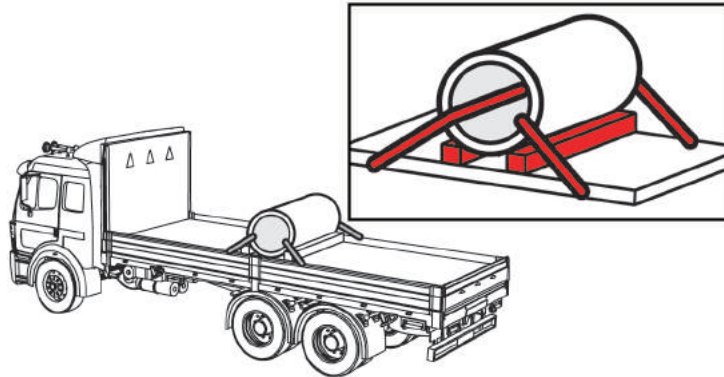

Requirements for securing a single coil (Section 3.3.3.1)

Prevent the coil from rolling

- ◆ Prevent the coil from rolling by supporting it:
 - Timbers, chocks, or wedges held in place by coil bunks or similar devices to prevent them from coming loose.
 - A cradle (for example, two hardwood timbers and two coil bunks) that is restrained from sliding by:
 - Friction mats under the cradle.
 - Nailed wood blocking or cleats.
 - Placing a tiedown around the front of the cradle.
- ◆ The support must:
 - Support the coil just above the deck.
 - Not become unintentionally unfastened or loose in transit.

5. Metal Coils

Requirements for securing a single coil (Section 3.3.3.1) (continued)



The use of nailed blocking or cleats as the sole means to secure timbers, chocks or wedges, or a nailed wood cradle, is prohibited.

5. Metal Coils

Securing Coils Transported With Eyes Crosswise on a Vehicle with Anchor Points (Section 3.3.3) (continued)

Securing a Single Coil (Section 3.3.3.1) (continued)

One tiedown forward

- ◆ Attach at least one tiedown through the eye of the coil to restrain against forward motion.
 - If possible, the angle between the tiedown and the deck should be **less than 45°**.

One tiedown rearward

- ◆ Attach at least one tiedown through the eye of the coil to restrain against rearward motion.
 - If possible, the angle between the tiedown and the deck should be **less than 45°**.

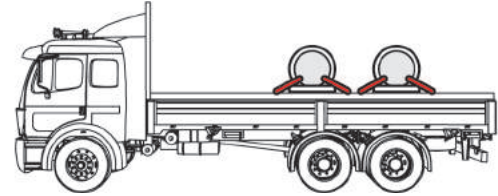

Correct use of tiedowns for single coil



Attaching tiedowns diagonally through the eye of a coil to form an X-pattern when viewed from above the vehicle is **prohibited**. (Section 3.3.3.2)

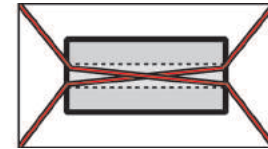

X-pattern prohibited for tiedowns



If a tiedown is used around the front of the cradle, it does not count towards the aggregate WLL for tiedowns through the eye of the coil.

5. Metal Coils

Securing Coils Transported With Eyes Lengthwise on a Vehicle with Anchor Points (Section 3.3.4)

Requirements for securing an individual coil

There are three options for safely securing individual coils that are loaded with their eyes lengthwise. Blocking and supporting the coils is the same. The difference is in the tiedown arrangement.

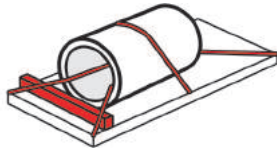

Eyes Lengthwise

Prevent the coil from rolling

- ◆ Prevent the coil from rolling by supporting it:
 - Timbers, chocks, or wedges held in place by coil bunks or similar devices to prevent them from coming loose.

- A cradle (for example, two hardwood timbers and two coil bunks) that is restrained from sliding by:
 - Placing friction mats under the cradle
 - Using nailed wood blocking or cleats against the front timber
 - Placing a tiedown around the front of the cradle.
- ◆ The support must:
 - Support the coil off the deck.
 - Not become unintentionally unfastened or loose in transit.



The use of nailed blocking or cleats as the sole means to secure timbers, chocks or wedges, or a nailed wood cradle, is **prohibited**.

5. Metal Coils

Securing Coils Transported With Eyes Lengthwise on a Vehicle with Anchor Points (Section 3.3.4) (continued)

Tiedowns, Single Coil Option #1 (Section 3.3.4.1)

- ◆ Attach at least one tiedown diagonally from the left side of the vehicle, through the eye, to the right side of the vehicle.
 - If possible, the angle between the tiedown and the deck should be less than 45°, when viewed from the side of the vehicle.
- ◆ Attach at least one tiedown diagonally from the right side of the vehicle, through the eye, to the left side of the vehicle.
 - If possible, the angle between the tiedown and the deck should be less than 45°, when viewed from the side of the vehicle.
- ◆ Attach at least one tiedown side-to-side over the top of the coil.
- ◆ Use blocking or friction mats to prevent forward movement.

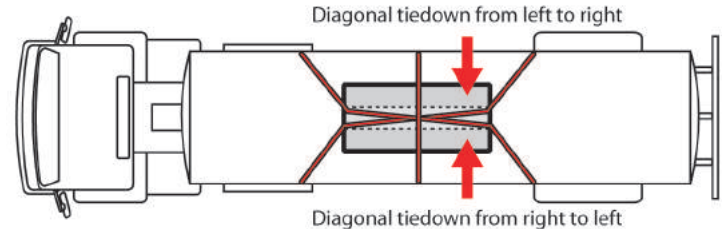

Option #1 Single Coil (Eye Lengthwise)

5. Metal Coils

Securing Coils Transported With Eyes Lengthwise on a Vehicle with Anchor Points (Section 3.3.4) (continued)

Tiedowns, Single Coil Option #2 (Section 3.3.4.2)

Option #2 is the same as Option #1, except the tiedowns that attach through the eye of the coil are straight instead of diagonal.

- ◆ Attach at least one tiedown straight from the left side of the vehicle, through the eye, and back to the left side of the vehicle.
 - If possible, the angle between the tiedown and the deck should be less than 45°, when viewed from the side of the vehicle.
- ◆ Attach at least one tiedown straight from the right side of the vehicle, through the eye, and back to the right side of the vehicle.
 - If possible, the angle between the tiedown and the deck should be less than 45°, when viewed from the side of the vehicle.

- ◆ Attach at least one tiedown side-to-side over the top of the coil.
- ◆ Use blocking or friction mats to prevent forward movement.

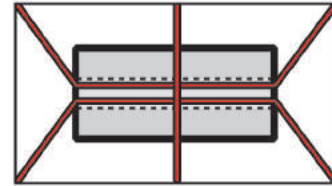

Option #2 Single Coil (Eye Lengthwise)

5. Metal Coils

Securing Coils Transported With Eyes Lengthwise on a Vehicle with Anchor Points (Section 3.3.4) (continued)

Tiedowns, Single Coil Option #3 (Section 3.3.4.3)

Option #3 is the same as Options #1 and #2, except that the two tiedowns that attach through the eye of the coil are replaced with two tiedowns that pass over the front and the rear of the coil.

- ◆ Attach at least one tiedown over the top of the coil near the front of the coil.
- ◆ Attach at least one tiedown over the top of the coil near the rear of the coil.
- ◆ Use blocking or friction mats to prevent forward movement.

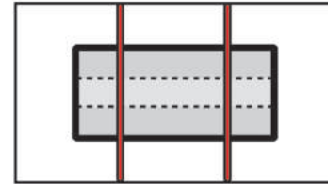

Option #3 Single Coil (Eye Lengthwise)

5. Metal Coils

Securing Coils Transported With Eyes Lengthwise on a Vehicle with Anchor Points (Section 3.3.4) (continued)

Requirements for securing rows of coils (Section 3.3.4.4)

A row of coils is three or more coils loaded in the same way and in a line.

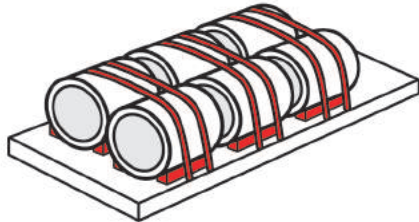

Row of Coils

Prevent the coil from rolling

- ◆ Prevent the coil from rolling by supporting it:
 - Timbers, chocks, or wedges held in place by coil

bunks or similar devices to prevent them from coming loose.

- A cradle (for example, two hardwood timbers and two coil bunks) that is restrained from sliding by:
 - Placing friction mats under the cradle
 - Using nailed wood blocking or cleats against the front timber
 - Placing a tiedown around the front of the cradle.
- ◆ The support must:
 - Support the coil just above the deck.
 - Not become unintentionally unfastened or loose in transit.



The use of nailed blocking or cleats as the sole means to secure timbers, chocks or wedges, or a nailed wood cradle, is **prohibited**.

5. Metal Coils

Securing Coils Transported With Eyes Lengthwise on a Vehicle with Anchor Points (Section 3.3.4) (continued)

Requirements for securing rows of coils (Section 3.3.4.4) (continued)

Tiedowns

- ◆ Attach at least one tiedown over the top of each coil or side-by-side row, located near the front of the coil.
- ◆ Attach at least one tiedown over the top of each coil or side-by-side row, located near the rear of the coil.
- ◆ Use blocking or friction mats to prevent forward movement.

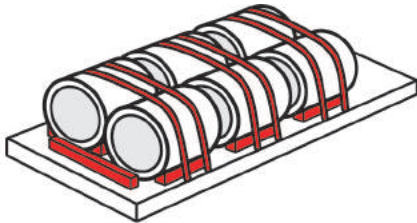

Acceptable securing of a row of coils (Eyes Lengthwise)

Securing Coils Transported in a Sided Vehicle or Intermodal Container without Anchor Points (Section 3.3.5)

To prevent metal coils from moving horizontally and/or tipping:

- ◆ Follow general cargo securement requirements (Section 2).
- ◆ Secure the coils using:
 - Blocking and bracing
 - Friction mats
 - A combination of these.

The securement system used must prevent movement in directions (see Section 1).

6. Paper Rolls

What Does This Section Cover? p. 67

Special Circumstances

- Loading and Securing Paper Rolls
with Eyes Vertical in a Sided Vehicle p. 68
- Loading and Securing Paper Rolls
with Eyes Horizontal in a Sided Vehicle p. 75
- Loading and Securing Paper Rolls
on a Flatbed Vehicle or in a Curtain-Sided Vehicle p. 80



6. Paper Rolls

What Does This Section Cover? (Section 3.4.1)

The rules in this section apply to shipments of paper rolls, which individually or together, weigh 2268 kg (5000 lb.) or more.



Shipments of paper rolls that weigh **less than 2268 kg (5000 lb.)**, and paper rolls that are unitized on a pallet may either be secured in accordance this section or with the general cargo securement requirements (Section 2).



This section does not apply to small rolls of paper shipped in cartons/containers such as toilet paper or paper towels that would be used in the kitchen. This type of product is covered in the general cargo securement requirements (Section 2).

Plan a Securement System for Paper Rolls

- ◆ Select a good load pattern.
- ◆ Block, brace, or immobilize paper rolls to make sure they are prevented from sliding, tipping, or rolling.
- ◆ Prevent significant movement of small groups of paper rolls when movement is not prevented by other cargo or by the vehicle structure.
- ◆ Symmetrically stack paper rolls when eyes are horizontal.
- ◆ Make sure that stacks are secured to prevent significant movement.
- ◆ Use friction mats to prevent horizontal movement.
- ◆ Use tiedowns that pass over the paper rolls to increase the effect of friction.
- ◆ Use tiedowns when rolls are loaded on flatbeds or curtain-sided vehicles.

6. Paper Rolls

Special Circumstances: Loading and Securing Paper Rolls with Eyes Vertical in a Sided Vehicle (Section 3.4.2)

Requirements for placement

- ◆ Place paper rolls together in a group so that the structure of the group can be maintained.
- ◆ Place paper rolls against:
 - The front and walls of the vehicle
 - Each other
 - Other cargo.
- ◆ Usually the roll is secure if a paper roll has 3 well-separated points of contact with the vehicle, other rolls, or other cargo.

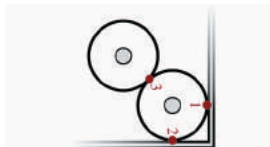

3 Points of Contact

Requirements for preventing side-to-side movement

If there are not enough paper rolls in the shipment to reach the walls of the vehicle, prevent side-to-side movement by one of these methods:

- ◆ Blocking
- ◆ Bracing
- ◆ Tiedowns
- ◆ Void fillers
- ◆ Friction mats
- ◆ Banding the rolls together

6. Paper Rolls

Special Circumstances: Loading and Securing Paper Rolls with Eyes Vertical in a Sided Vehicle (Section 3.4.2) (continued)

Requirements for preventing rearward movement

When any void behind a group of paper rolls (including rolls at the rear of the vehicle) is greater than the diameter of the paper rolls, prevent rearward movement by one of these methods.

- ◆ Friction mats
- ◆ Blocking
- ◆ Bracing
- ◆ Tiedowns
- ◆ Banding to other rolls

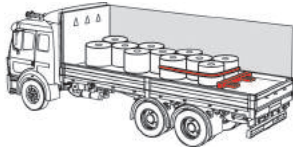

Prevent Rearward Movement

Requirements for preventing paper rolls from tipping

Situation #1:

- ◆ Paper roll is not prevented from tipping by the vehicle structure or other cargo.
- ◆ Paper roll width is more than 2 times its diameter.

Solution #1:

- ◆ Either band the roll to other rolls.
- ◆ Or brace it.
- ◆ Or use tiedowns.

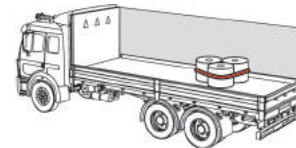

Width is two times greater than the diameter

6. Paper Rolls

Special Circumstances: Loading and Securing Paper Rolls with Eyes Vertical in a Sided Vehicle (Section 3.4.2) (continued)

Prevent paper rolls from tipping (continued)

Situation #2:

- ◆ The forwardmost roll(s) in a group of paper rolls is not prevented from tipping or falling forward by vehicle structure or other cargo.
- ◆ Paper roll width is more than 1.75 times its diameter.

Solution #2:

- ◆ Either band the roll to other rolls.
- ◆ Or brace it.
- ◆ Or use tiedowns.



6. Paper Rolls

Special Circumstances: Loading and Securing Paper Rolls with Eyes Vertical in a Sided Vehicle (Section 3.4.2) (continued)

Prevent paper rolls from tipping (continued)

Situation #3:

- ◆ A paper roll or the forwardmost roll(s) in a group of paper rolls is not prevented from tipping or falling forward by vehicle structure or other cargo.
- ◆ Paper roll width is more than 1.25 times its diameter.
- ◆ Blocking is used to prevent forward movement.

Solution #3:

The blocking tends to “trip” the roll so additional tipping securement is required.

- ◆ Either band the roll to other rolls.
- ◆ Or brace it.
- ◆ Or use tiedowns.



6. Paper Rolls

Special Circumstances: Loading and Securing Paper Rolls with Eyes Vertical in a Sided Vehicle (Section 3.4.2) (continued)

Prevent paper rolls from tipping (continued)

Situation #4

- ◆ A paper roll or the forwardmost roll(s) in a group of paper rolls is not prevented from tipping or falling forward by vehicle structure or other cargo.
- ◆ Paper roll width is more than 1.25 times and less than 1.76 times its diameter.
- ◆ Only friction mats are used for forward securement.

Solution #4:

The friction mat alone is adequate. The friction mat allows the roll to slide on the floor without tripping the roll.

Banding

If paper rolls are banded together:

- ◆ Place rolls tightly against each other to form a stable group.
- ◆ Apply bands tightly.
- ◆ Secure bands with tape, hangers, or other means so that the bands cannot fall off the rolls or slide down to the deck.

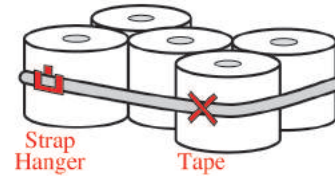

Band Supports

6. Paper Rolls

Special Circumstances: Loading and Securing Paper Rolls with Eyes Vertical in a Sided Vehicle (Section 3.4.2) (continued)

Requirements for friction mats

If a friction mat is used to provide the principal securement for a paper roll, insert the friction mat so that it sticks out from beneath the footprint of the roll in the direction in which it is providing securement.



Special Circumstances: Loading and Securing Paper Rolls with Eyes Vertical in a Sided Vehicle (Section 3.4.3)

Requirements for split loads

Situation

A paper roll in a split load is not prevented from forward movement by the vehicle structure or other cargo.

Solution

Prevent forward movement by one of these methods.

- ◆ Friction mats
- ◆ Filling the open space
- ◆ Blocking
- ◆ Bracing
- ◆ Tiedowns
- ◆ Some combination of these

6. Paper Rolls

Special Circumstances: Loading and Securing Paper Rolls with Eyes Vertical in a Sided Vehicle (Section 3.4.4)

Stacked Loads

- ◆ Load paper rolls on a second layer only if the bottom layer extends to the front of the vehicle.
- ◆ Prevent forward, rearward, or side-to-side movement:
 - Either by the same means required for the bottom layer
 - Or by the use of a blocking roll from a lower layer.
- ◆ A roll in the rearmost row of any layer must not be raised using dunnage.



The Blocking Row

Blocking row must be **at least 38 mm (1.5 in)** taller than other rolls, or must be raised **at least 38 mm (1.5 inches)** using dunnage.



6. Paper Rolls

Special Circumstances: Loading and Securing Paper Rolls with Eyes Horizontal in a Sided Vehicle (Section 3.4.5)

Requirements for eyes crosswise: prevent forward and rearward movement

- ◆ To prevent paper rolls from rolling or shifting in the forward and rearward directions:
 - Either position the rolls in contact with the vehicle structure or other cargo.
 - Or use chocks, wedges, tiedowns, blocking, and bracing.



Chocks, wedges or blocking used to secure intermediate rolls from forward or rearward movement during loading do not have to be secured in place.



Chocks, Wedges, or Blocking Securing the Front or Rear Roll
Hold in place by some means in addition to friction so they cannot become unintentionally unfastened or loose while the vehicle is in transit. This is often accomplished with nails.



6. Paper Rolls

Special Circumstances: Loading and Securing Paper Rolls with Eyes Horizontal in a Sided Vehicle

(Section 3.4.5) (continued)

Requirements for eyes crosswise: secure rearmost roll

Do not secure the rearmost roll with:

- ◆ Either the rear doors of the vehicle or intermodal container
- ◆ Or blocking held in place by those doors.

The doors are not designed or intended as a cargo securing device. The rolls may push the doors open during transit or onto loading dock personnel when the doors are opened.

Requirements for eyes crosswise: prevent rolls from shifting toward either wall

If there is more than a total of 203 mm (8 in) of space between the ends of a paper roll and other rolls or the walls of the vehicle, use one of these methods:

- ◆ Void fillers (such as honeycomb)
- ◆ Blocking
- ◆ Bracing
- ◆ Friction mats
- ◆ Tiedowns

6. Paper Rolls

Special Circumstances: Loading and Securing Paper Rolls with Eyes Horizontal in a Sided Vehicle (Section 3.4.6)

Requirements for eyes crosswise: secure stacks of paper rolls from front-to-back movement

- ◆ Do not load paper rolls on a second layer unless the bottom layer extends to the front of the vehicle.
- ◆ Load paper rolls on higher layers only if all wells in the layer beneath are filled.



- ◆ Secure the foremost roll in each upper layer (or any roll with an empty well in front of it) against forward movement:
 - Either by placing it in a well formed by two rolls on the lower row whose diameter is equal to or greater than that of the roll on the upper row.
 - Or by banding it to other rolls.
- ◆ Or by blocking it against an eye-vertical blocking roll resting on the floor of the vehicle that is at least 1.5 times taller than the diameter of the roll being blocked.

6. Paper Rolls

Special Circumstances: Loading and Securing Paper Rolls with Eyes Horizontal in a Sided Vehicle (Section 3.4.6) (continued)

Requirements for eyes crosswise: secure stacks of paper rolls from front-to-back movement (continued)

- ◆ If the rearmost roll in each upper layer is located in either of the last two wells formed by the rearmost rolls in the layer below, band it to the other rolls.

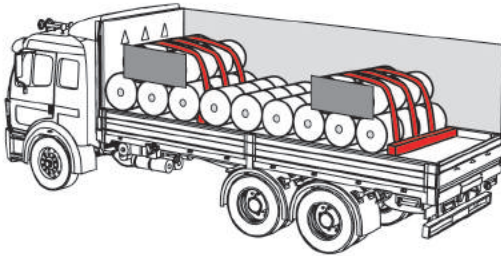

No paper rolls in second layer unless bottom layer extends to front of vehicle

Requirements for eyes crosswise: prevent stacked rolls from shifting toward either wall

If there is more than a total of 203 mm (8 in) of space between the ends of a paper roll and other rolls or the walls of the vehicle, use one of these methods.

- ◆ Void fillers (such as honeycomb)
- ◆ Blocking
- ◆ Bracing
- ◆ Friction mats
- ◆ Tiedowns

These are the same requirements that are used to secure a single layer of paper rolls.

6. Paper Rolls

Special Circumstances: Loading and Securing Paper Rolls with Eyes Horizontal in a Sided Vehicle (Section 3.4.7)

Requirements for eyes lengthwise: prevent movement

Direction of Potential Movement	Methods to Prevent Movement
Forward	<ul style="list-style-type: none">◆ Vehicle structure◆ Other cargo◆ Blocking◆ Tiedowns
Rearward	<ul style="list-style-type: none">◆ Other cargo◆ Blocking◆ Fiction mats◆ Tiedowns
Side – to – Side	<ul style="list-style-type: none">◆ Vehicle wall◆ Other cargo◆ Chocks, wedges, or blocking of adequate size



Chocks, Wedges, or Blocking Securing the Front or Rear Roll
Hold in place by some means in addition to friction so they cannot become unintentionally unfastened or loose while the vehicle is in transit. This is often accomplished with nails.

6. Paper Rolls

Special Circumstances: Loading and Securing Paper Rolls with Eyes Horizontal in a Sided Vehicle (Section 3.4.8)

Requirements for eyes lengthwise: stacked loads

- ◆ Do not load paper rolls in an upper layer if another roll will fit in the layer beneath.
- ◆ Form an upper layer by placing the paper rolls in the wells formed by the rolls beneath.

Eyes lengthwise: prevent forward and rearward movement

- ◆ Secure a roll in an upper layer against forward and rearward movement:
 - Either by any of the means required for the bottom layer.
 - Or by using a blocking roll.
 - Or by banding it to other rolls.

Special Circumstances: Loading and Securing Paper Rolls on a Flatbed Vehicle or a Curtain-Sided Vehicle (Section 3.4.9)

Requirements for eyes vertical or with eyes horizontal and lengthwise (Section 3.4.9.1)

- ◆ Load and secure the paper rolls as described for a sided vehicle.
- ◆ Attach tiedowns to secure entire load according to the general cargo securement requirements in Section 2.



Stacked loads of paper rolls with eyes vertical are prohibited.

6. Paper Rolls

Special Circumstances: Loading and Securing Paper Rolls on a Flatbed Vehicle or a Curtain-Sided Vehicle (Section 3.4.9) (continued)

Requirements for eyes crosswise (Section 3.4.9.2)

- ◆ Prevent each roll from rolling or shifting forward and rearward by:
 - Contact with the vehicle structure.
 - Contact with other cargo.
 - Chocks, wedges, blocking or bracing of adequate size.
 - Tiedowns.
- ◆ Use side-to-side or front-to-back tiedowns to prevent side-to-side movement.



Chocks, wedges, and blocking must be held in place by some additional means to friction so they may not become unfastened or loose while the vehicle is in transit.



7. Concrete Pipe Loaded Crosswise

- What Does This Section Cover? p. 83
- Securing Concrete Pipe p. 84
- Arranging the Load p. 86
- Special Circumstances
 - Securing Pipe with an Inside Diameter up to 1.143 mm (45 in) p. 90
 - Securing Large Pipe with an Inside Diameter over 1.143 mm (45 in) p. 93



7. Concrete Pipe Loaded Crosswise

What Does This Section Cover? (Section 3.5.1)

The specific requirements for concrete pipe apply to the transportation of certain concrete pipe loaded crosswise on a platform trailer or vehicle.

What is exempt from these specific requirements?

Follow general cargo securement requirements (Section 2) when transporting the following pipe:

- ◆ Concrete pipe that is grouped together into a single rigid article and may not roll.
- ◆ Concrete pipe loaded in a sided vehicle or container.
- ◆ Concrete pipe eyes vertical and concrete pipe loaded lengthwise.

What is covered under these specific requirements?

- ◆ Any concrete pipe loaded crosswise on a platform trailer or vehicle that is not exempt.

7. Concrete Pipe Loaded Crosswise

Securing Concrete Pipe

To make sure that concrete pipe does not roll or slide:

- ◆ Load pipe as compactly as possible.
- ◆ Immobilize symmetrically stacked pipes by securing them in groups.
- ◆ Use blocking systems and tiedowns to increase the effect of friction.

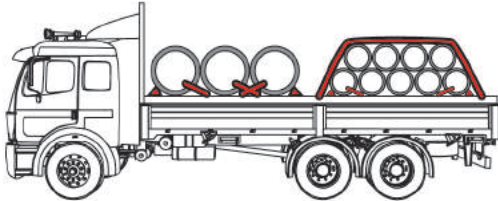

General tiedown requirements (Section 3.5.2)

- ◆ The aggregate working load limit of all tiedowns on any group of pipe must be more than half the total weight of all pipes in the group.
- ◆ Run a properly tensioned tiedown through a pipe in an upper tier or over lengthwise tiedowns. It will secure all the pipe beneath it on which the tiedown causes pressure.

7. Concrete Pipe Loaded Crosswise

Securing Concrete Pipe (continued)

Blocking requirements (Section 3.5.3)

- ◆ Blocking must prevent the pipe from rolling or rotating.
- ◆ Blocking may be one or more pieces placed at equal distances from the center of a pipe
- ◆ There are two blocking options:
 - Place one piece of blocking so that it extends at least half the distance from the center to each end of the pipe.

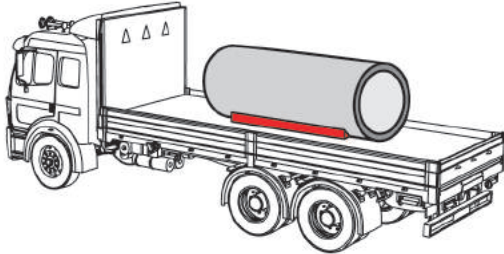

Blocking Option #1

- Place two pieces of blocking at the outside quarter points.

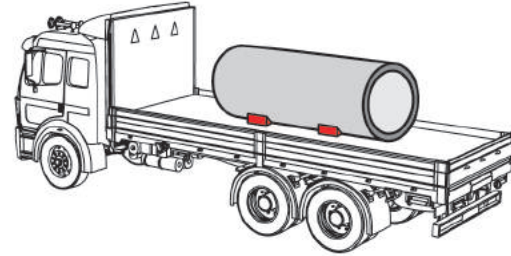

Blocking Option #2

7. Concrete Pipe Loaded Crosswise

Securing Concrete Pipe (continued)

Blocking requirements (Section 3.5.3) (continued)

- ◆ Blocking must be:
 - Placed against the pipe
 - Secured to prevent it from moving out from under the pipe.
- ◆ Timber blocking must have a minimum nominal dimension of 10 x 15 cm (4 x 6 in).

Arranging the Load (Section 3.5.4)

Requirements for arranging pipe with different diameter (Section 3.5.4.1)

- ◆ Load pipe of more than one diameter in groups that consist of pipe of only one size.
- ◆ Secure each group of pipe separately.



Arranging pipe with different diameter

7. Concrete Pipe Loaded Crosswise

Arranging the Load (continued)

Requirements for arranging a bottom tier (Section 3.5.4.2)

There are two ways to arrange the bottom tier:

- ◆ Cover the full length of the vehicle.



Arranging a bottom tier - Option #1

- ◆ Arrange as a partial tier in one or two groups.

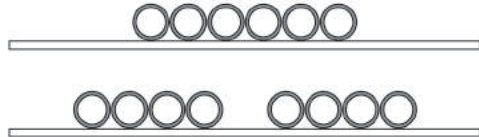

Arranging a bottom tier - Option #2

Requirements for arranging an upper tier (Section 3.5.4.3)

- ◆ Place pipe only in the wells formed by pipes in the tier below.
- ◆ Do not start an additional tier unless all wells in the tier beneath are filled.

7. Concrete Pipe Loaded Crosswise

Arranging the Load (Section 3.5.4) (continued)

Requirements for arranging the top tier (Section 3.5.4.4)

- ◆ Arrange the top tier as a complete tier, a partial tier in one group, or a partial tier in two groups.

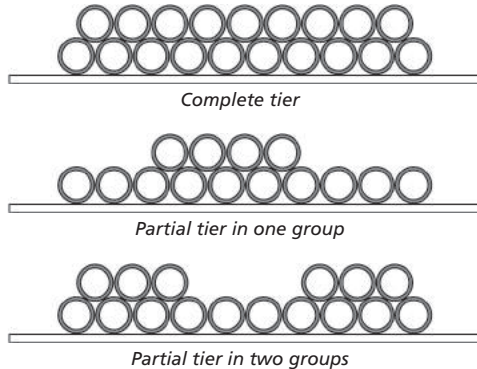

Requirements for arranging bell pipe (Section 3.5.4.5)

On spacers

- ◆ Load bell pipe on at least two longitudinal spacers tall enough to ensure that the bell is clear of the deck.

One tier

- ◆ Load bell pipe on one tier so that the bells alternate on opposite sides of the vehicle.
- ◆ If possible, the ends of consecutive pipe must be staggered within the allowable width.
- ◆ If the ends cannot be staggered, they must be aligned.

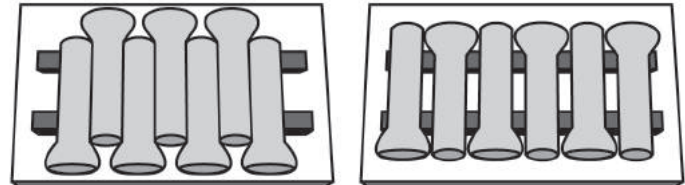

Staggered ends

Aligned ends

7. Concrete Pipe Loaded Crosswise

Requirements for arranging bell pipe (Section 3.5.4) (continued)

More than one tier with complete tiers

- ◆ Bells of the bottom tier must all be on the same side of the vehicle
- ◆ Bells of the upper tiers must be on the opposite side of the vehicle from the bells of the tier below.

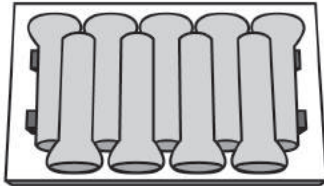

Alternate bell ends from tier to tier

More than one tier with partial upper tier

- ◆ Pipe in the bottom tier that do not support a pipe above must have their bells alternating on opposite sides of the vehicle.

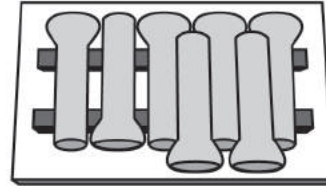

Alternate bell ends when pipe on bottom does not support pipe above

7. Concrete Pipe Loaded Crosswise

Special Circumstances: Securing Pipe with an Inside Diameter Up to 1.143 m (45 in) (Section 3.5.5)

Concrete pipe with an inside diameter up to 1.143 m (45 in) can form a complete single tier on a typical flatbed vehicle. Larger pipe often can only be carried as a partial tier.



This pipe diameter of 1.143 m (45 in) is simply a convenient breaking point between “medium” and “large” diameter pipe.



At least one tiedown through the front pipe of the bottom tier must run rearward at an angle not more than 45° with the horizontal when viewed from the side of the vehicle, whenever practical.

At least one tiedown through the rear pipe of the bottom tier must run forward at an angle not more than 45° with the horizontal when viewed from the side of the vehicle, whenever practical.

Requirements for stabilizing the bottom tier (Section 3.5.5.1)

- ◆ Arrange the load properly (see 3.5.4)
- ◆ Immobilize the front and rear pipe with one of the following elements.
 - Blocking
 - Wedges
 - Vehicle end structure
 - Stakes
 - Locked pipe unloader
 - Other equivalent means

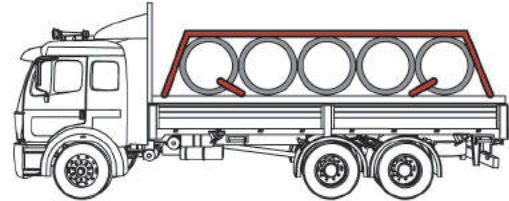

Appropriate stabilization of bottom tier

7. Concrete Pipe Loaded Crosswise

Special Circumstances: Securing Pipe with an Inside Diameter Up to 1.143 m (45 in) (Section 3.5.5) (continued)

Tiedown requirements (Section 3.5.5.2)

- ◆ Pipe may be secured individually or as a group.
- ◆ Tiedowns through the pipe must be chains.
- ◆ Front-to-back tiedowns may be chain or wire rope.

Individually

- ◆ Run a tiedown through the pipe.

As a group

- ◆ Place lengthwise tiedowns over the group of pipes:
 - Either one 13 mm (1/2 in) chain or wire rope
 - Or two 10 mm (3/8 in) diameter chain or wire rope

- ◆ Place one crosswise tiedown for every 3.0 m (10 ft) of load length.
 - Either attach the side-to-side tiedown through a pipe
 - Or pass the tiedown over both front-to-back tiedowns between two pipes on the top tier.

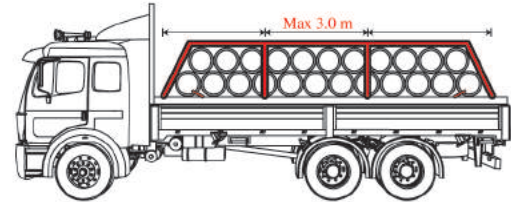

Appropriate use of tiedowns for a group of pipes

7. Concrete Pipe Loaded Crosswise

Special Circumstances: Securing Pipe with an Inside Diameter Up to 1.143 mm (45 in) (continued)

Requirements for stabilizing the top tier (Section 3.5.5.2)

If the first pipe of a group in the top tier is not at the front of the tier beneath:

- ◆ Attach an additional tiedown that runs rearward at an angle not more than 45° to the horizontal when viewed from the side of the vehicle, whenever practicle.
- ◆ Pass tiedown either through the front pipe of the upper tier or outside the front pipe and over both longitudinal tiedowns.

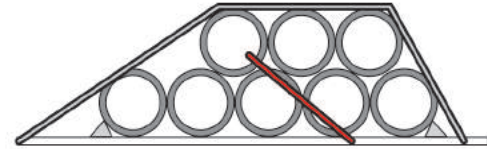

Correct secorement of front pipe in partial second tier

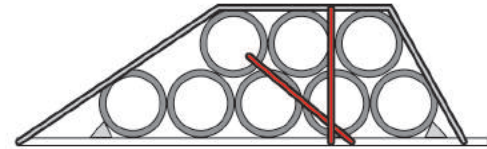

Correct secorement of front pipe in partial

7. Concrete Pipe Loaded Crosswise

Special Circumstances: Securing Large Pipe with an Inside Diameter over 1143 mm (45 in) (Section 3.5.6)

Requirements for stabilizing the pipe

- ◆ Arrange the load properly (see 3.5.4)
- ◆ Immobilize the front and rear pipe with one of the following methods:
 - Blocking
 - Wedges
 - Vehicle end structure
 - Stakes
 - Locked pipe unloader
 - Other equivalent means
- ◆ For all other pipe, use additional blocks and/or wedges that are nailed in place.

Requirements for securing the pipe

- ◆ Secure each pipe with tiedowns through the pipe.
- ◆ Run at least one tiedown through each pipe in the front half of the load. This includes the middle one if there are an odd number. The tiedown must run rearward at an angle not more than 45° with the horizontal when viewed from the side of the vehicle, whenever practicable.
- ◆ Run at least one tiedown through each pipe in the rear half of the load. The tiedown must run forward at an angle not more than 45° with the horizontal when viewed from the side of the vehicle, whenever practicable. This holds each pipe firmly in contact with adjacent pipe.
- ◆ Run at least two tiedowns through the front and rear pipe if they are not also in contact with vehicle end structure, stakes, a locked pipe unloader, or other equivalent means.



Correct securing of large pipe

7. Concrete Pipe Loaded Crosswise

Special Circumstances: Securing Large Pipe with an Inside Diameter over 1143 mm (45 in) (Section 3.5.6) (continued)

Requirements for securing the pipe (continued)

- ◆ Run at least two tiedowns through the front and rear pipe if they are not also in contact with one of the following:
 - Either the vehicle end structure
 - Or the stakes
 - Or a locked pipe unloader
 - Or other equivalent means.



If only one pipe is transported, or if several pipes are transported without contact between other pipes, the requirements of this section apply to each pipe as a single front and rear article. Tiedowns must be used through that pipe.

8. Intermodal Containers

- What Does This Section Cover? p. 96
- Special Circumstances
 - Securing Loaded Intermodal Containers on Container Chassis Vehicles p. 97
 - Securing Loaded Intermodal Containers on Non-Chassis Vehicles p. 98
 - Securing Empty Intermodal Containers on Non-Chassis Vehicles p. 99



8. Intermodal Containers

What Does This Section Cover? (Section 3.6.1)

The requirements in this section apply to the transportation of all intermodal containers.



When securing cargo contained within an intermodal container, follow general cargo securement requirements (Section 2) or, if applicable, follow the commodity specific requirements.

8. Intermodal Containers

Special Circumstances: Securing Loaded Intermodal Containers on Container Chassis Vehicles (Section 3.6.2)

Requirements for securing the container

- ◆ Secure each intermodal container to the container chassis with securement or integral locking devices that cannot accidentally become unfastened. Integral locking devices do not have to be adjustable.

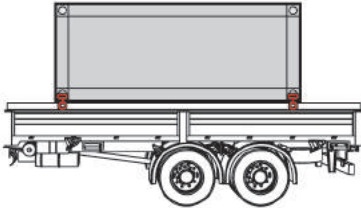

Integral Locking Device



If necessary, use secondary attachments to ensure that latches remain fastened in transit.

- ◆ Securing devices must restrain the container from moving more than:
 - 1.27 cm (1/2 in) forward.
 - 1.27 cm (1/2 in) rearward.
 - 1.27 cm (1/2 in) to the right.
 - 1.27 cm (1/2 in) to the left.
 - 2.54 cm (1 in) vertically.
- ◆ Secure the front and rear of the container independently.
 - 2 latches on the chassis engage anchor points towards or at the front of the container.
 - 2 latches on the chassis engage anchor points towards or at the rear of the container.
- ◆ If a latch is missing or broken, secure the corner by an alternative means, such as:
 - Chain.
 - Wire rope.

8. Intermodal Containers

Special Circumstances: Securing Loaded Intermodal Containers on Non-Chassis Vehicles (Section 3.6.3)

Requirements for positioning the container

- ◆ Position the intermodal container so that:
 - Either all lower corners rest upon the vehicle.
 - Or the corners are supported by a structure capable of bearing the weight of the container. Independently secure the support structure to the vehicle.

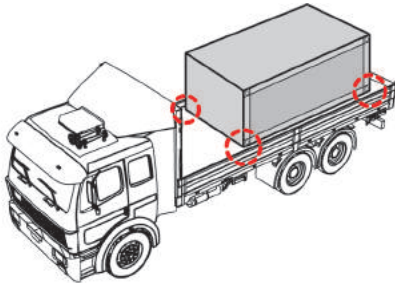

All four corners are resting upon the vehicle

Requirements for securing the container

- ◆ Secure each container to the vehicle by:
 - Either chains, wire ropes, or integral devices that are fixed to all lower corners.
 - Or crossed chains that are fixed to all upper corners.
 - Or both.
- ◆ Secure the front and rear of the loaded container independently.
- ◆ Secure the four corners using tiedowns that are attached to the loaded container.
 - The tiedowns must have an aggregate working load limit of at least 50% of the loaded weight of the loaded container.
- ◆ Attach each chain, wire rope, or integral locking device to the container in a manner that prevents it from becoming unfastened while in transit.

8. Intermodal Containers

Special Circumstances: Securing Empty Intermodal Containers on Non-Chassis Vehicles (Section 3.6.4)

Empty intermodal containers transported on non-chassis vehicles do not have to have all lower corners resting upon the vehicle or supported by a structure if they meet each of the following four requirements:

- ◆ Requirement 1: The container is balanced and positioned on the vehicle so it is stable before adding tiedowns or other securing devices.
- ◆ Requirement 2: The container does not hang over the front or rear of the trailer by more than 1.5 m (5 ft).
- ◆ Requirement 3: The container does not interfere with the vehicle's maneuverability.
- ◆ Requirement 4: The container is secured to prevent side-to-side, forward, rearward, and upward movement by:
 - Either by following the requirements for loaded containers.
 - Or by following the general cargo securement requirements (Section 2) for tiedowns.

Automobiles, Light Trucks, and Vans

What Does This Section Cover? p. 101
Securing Automobiles, Light Trucks, and Vans p. 102



Automobiles, Light Trucks, and Vans

What Does This Section Cover? (Section 3.7.1)

The requirements in this section apply to the transportation of automobiles, light trucks, and vans that individually weigh 4500 kg (10,000 lb.) or less.



Vehicles that are heavier than 4500 kg (10,000 lb.) must be secured in accordance with the provisions of Section 10, Heavy Vehicles, Equipment, and Machinery.

Automobiles, Light Trucks, and Vans

Securing Automobiles, Light Trucks, and Vans (Section 3.7.2)

Tiedowns attached to the vehicle being transported are the most effective securement system.

Securement requirement

- ◆ Use at least two tiedowns at both the front and rear of the cargo to prevent movement.
 - Side-to-side
 - Forward and rearward
 - Vertically



More tiedowns may be required to satisfy the general cargo securement requirements. The Standard states: "The sum of the working load limits from all tiedowns must be at least 50% of the weight of the cargo."

Requirements for tiedowns designed to be affixed to the structure

- ◆ These tiedowns must use the securement mounting points on the vehicle that have been designed for that purpose.

Requirements for tiedowns designed to fit over or around the wheels

- ◆ Provide restraint in the side-to-side, forward, rearward, and vertical directions.

Edge protectors

- ◆ Not required for synthetic webbing at points where the webbing comes in contact with the tires.

10. Heavy Vehicles, Equipment, and Machinery

- What Does This Section Cover? p. 104
- Preparing Equipment Being Transported p. 105
- Securing Heavy Vehicles, Equipment, and Machinery p. 106



10. Heavy Vehicles, Equipment, and Machinery

What Does This Section Cover? (Section 3.8.1)

The requirements in this section apply to the transportation of heavy vehicles, equipment, and machinery that:

- ◆ Operate on wheels or tracks, such as front end loaders, bulldozers, tractors, and power shovels.
- ◆ Individually weigh more than 4500 kg (10,000 lb.).



Vehicles, equipment, and machinery that are **lighter than 4500kg (10,000 lb.)** may also be secured in accordance with the provisions of this section, as well as with the general cargo securement requirements (Section 2) or Section 9, Automobiles, Light Trucks, and Vans.

10. Heavy Vehicles, Equipment, and Machinery

Preparing Equipment To Be Transported (Section 3.8.2)

Requirements

- ◆ Lower and secure to the vehicle all accessory equipment (hydraulic shovels, booms, etc.).
- ◆ Restrain articulated vehicles to prevent articulation while in transit.

Parking Brake

- ◆ Set the parking brake on the equipment being transported.



10. Heavy Vehicles, Equipment, and Machinery

Special Circumstances: Securing Heavy Vehicles, Equipment, or Machinery with Crawler Tracks or Wheels (Section 3.8.2.1)

Tiedown requirements

- ◆ Restrain cargo using a minimum of four tiedowns, each having a WLL of at least 2,268 kg (5,000 lb.).
 - Prevents cargo movement in the side-to-side, forward, rearward, and vertical directions.
- ◆ Attach tiedowns:
 - Either at the front and rear of the vehicle.
 - Or at the mounting points on the vehicle designed for that purpose.

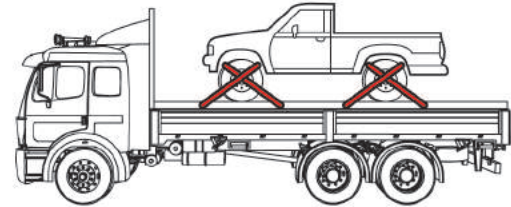

Cargo is restrained using at least 4 tiedowns



More tiedowns may be required to satisfy the general cargo securement requirements (Section 2) that state: "The sum of the working load limits from all tiedowns must be at least 50% of the weight of the cargo."

11. Flattened or Crushed Vehicles

What Does This Section Cover? p. 108
Securing Flattened or Crushed Vehicles p. 109



11. Flattened or Crushed Vehicles

What Does This Section Cover? (Section 3.9.1)

The requirements in this section apply to the transportation of vehicles such as automobiles, light trucks, and vans that have been flattened or crushed.

11. Flattened or Crushed Vehicles

Securing Flattened or Crushed Vehicles

Securement Requirements (Section 3.9.2)

- ◆ Transport flattened or crushed vehicles so that:
 - Cargo does not shift while in transit AND
 - Loose parts from the flattened vehicles do not dislodge and fall from the transport vehicle.
- ◆ Do not use synthetic webbing to secure vehicles.

Transport vehicle options (Section 3.9.2.1)

Secure flattened or crushed vehicles on a vehicle that meets one of the following four options.

- ◆ Option 1
 - Has containment walls on four sides that:
 - Extend to the full height of the load
 - Block against cargo movement in the forward, rearward, and sideways directions.
- ◆ Option 2
 - Has containment walls on three sides that:
 - Extend to the full height of the load
 - Block against cargo movement in the forward, rearward, and one sideways direction.
 - Secures each stack of vehicles with a minimum of two tiedowns, each having a minimum WLL of 2,268 kg (5,000 lb.).

11. Flattened or Crushed Vehicles

Securing Flattened or Crushed Vehicles (continued)

Vehicle options (3.9.2.1) (continued)

- ◆ Option 3
 - Has containment walls on two sides that:
 - Extend to the full height of the load.
 - Block against cargo movement in the forward and rearward.
 - Secures each stack of vehicles with a minimum of three tiedowns, each having a minimum WLL of 2,268 kg (5,000 lb.).
- ◆ Option 4
 - Has a minimum of four tiedowns per vehicle stack with each tiedown having a minimum WLL of 2,268 kg (5,000 lb.).



More tiedowns may be required to satisfy the general cargo securement requirement from Section 2 that state: “The sum of the working load limits from all tiedowns must be at least 50% of the weight of the cargo.”

Containing Loose Parts (Section 3.9.2.2)

- ◆ Use a containment system that:
 - Prevents loose parts from falling from all four sides of the vehicle AND
 - Extends to the full height of the cargo.
- ◆ The containment system can consist of one or a combination of the following methods.
 - Structural walls.
 - Sides or sideboards.
 - Suitable covering material.
- ◆ The use of synthetic material for containment of loose parts is permitted.

12. Roll-On/Roll-Off and Hook-Lift Containers

What Does This Section Cover? p. 112
Securing Roll-On/Roll-Off Containers p. 113



12. Roll-On/Roll-Off and Hook-Lift Containers

What Does This Section Cover? (Section 3.10.1)

The requirements in this section apply to the transportation of roll-on/roll-off and hook-lift containers.

Generally, roll-on/roll-off and hook-lift containers are carried on specially designed vehicles that are equipped with securing devices on the vehicle. When the container is secured, it combines the container and the vehicle into one unit.

12. Roll-On/Roll-Off and Hook-Lift Containers

Securing Roll-On/Roll-Off and Hook-Lift Containers (Section 3.10.2)

This section deals with how to transport a container on a vehicle that is not equipped with a compatible and functioning “Integral Securement System.”

Requirements for securing containers on a vehicle without an Integral Securement System

- ◆ Block against forward movement by the lifting device, stops, a combination of both, or another suitable restraint mechanism.
- ◆ Secure to the front of the vehicle by the lifting device or another suitable restraint to prevent side-to-side and vertical movement.
- ◆ Secure to the rear of the vehicle with at least one of the following three mechanisms:
 - **Rear Mechanism 1:** One tiedown attached to both the vehicle chassis and the container chassis.



- **Rear Mechanism 2:** Two tiedowns installed lengthwise, each securing one side of the container to one of the vehicle’s side rails.
- **Rear Mechanism 3:** Two hooks, or an equivalent mechanism, securing both sides of the container to the vehicle chassis at least as effectively as the tiedowns in the two previous items.

12. Roll-On/Roll-Off and Hook-Lift Containers

Securing Roll-On/Roll-Off and Hook Lift Containers (Section 3.10.2) (continued)

Requirements for securing containers on a vehicle without an Integral Securement System (continued)

- ◆ Attach mechanisms used to secure the rear end of a roll-on/roll-off or hook lift container no more than two meters from the rear of the container.

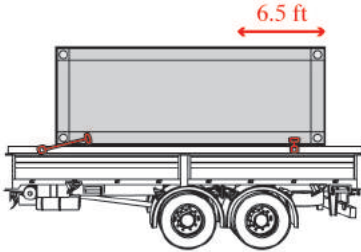

Each mechanism must have a WLL of at least 2,268 kg (5,000 lb.).

- ◆ Manually install additional tiedowns if one or more of the front stops or lifting devices is:
 - Missing.
 - Damaged.
 - Not compatible.
- ◆ Manually installed tiedowns must provide the same level of securement as the missing, damaged, or incompatible components.

13. Large Boulders

What Does This Section Cover?	p. 116
Positioning Boulders	p. 117
Tiedown Requirements	p. 119
Special Circumstances	
Securing a Cubic Shaped Boulder	p. 120
Securing a Non-Cubic Shaped Boulder With a Stable Base	p. 121
Securing a Non-Cubic Shaped Boulder With an Unstable Base	p. 122



13. Large Boulders

What Does This Section Cover? (Section 3.11.1)

The requirements in this section apply to any piece of natural, irregularly shaped rock that:

- ◆ Weighs more than 5,000 kg (11,000 lb.) or has a volume greater than two cubic meters
- ◆ Is transported on an open vehicle or in a vehicle whose sides are not designed and rated for the transportation of boulders.

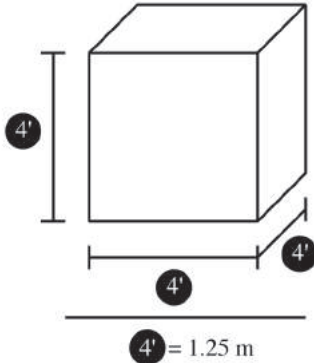

Two cubic meters (yards) is about the size of a box with dimensions of 1.25 (4 ft) on every side

Boulders weighing less than 5,000 kg (11,000 lb.) may be secured in one of two ways:

1. Using the requirements for large boulders (this section)
2. In some situations, using the general cargo securement requirements (Section 2) if:
 - ◆ Transported in a vehicle designed to carry boulders.
 - ◆ Boulders are stabilized and adequately secured by tiedowns.

Rock that is formed or cut to shape and has a stable base can be secured:

- ◆ Either by the requirements for large boulders.
- ◆ Or by the requirements for general cargo (Section 2).

13. Large Boulders

Positioning Boulders (Section 3.11.2)

Requirements

- ◆ Place each boulder on the vehicle with its flattest and/or largest side down.

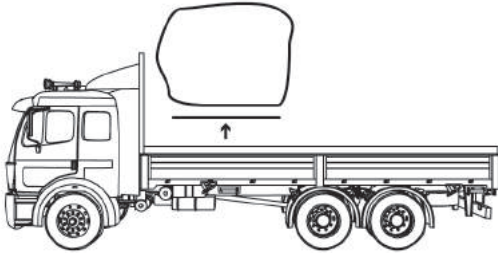

Flattest and/or largest side down

- ◆ Support each boulder on at least two pieces of hardwood blocking (at least 10 cm x 10 cm (4 x 4 in) that extend the full width of the boulder.
 - Place hardwood blocking pieces as symmetrically as possible under the boulder so they support at least 3/4 of the length of the boulder.

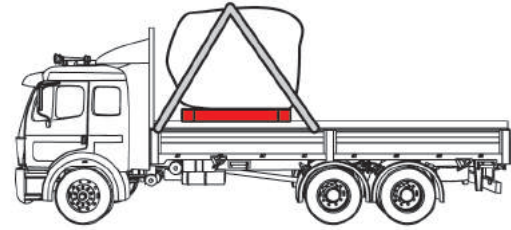

Hardwood blocking pieces placed under the boulder

13. Large Boulders

Positioning Boulders (Section 3.11.2) (continued)

Requirements

- ◆ If the flattest side of the boulder is rounded or partially rounded, place the boulder in a crib made of hardwood fixed to deck of vehicle.
 - Boulder should rest on both deck and timber, with at least 3 well-separated points of contact that prevent rolling in any direction.

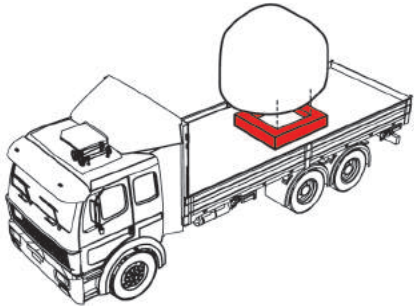

Boulder placed in a hardwood crib

- ◆ If a boulder is tapered, point the narrowest end towards the front of the vehicle.

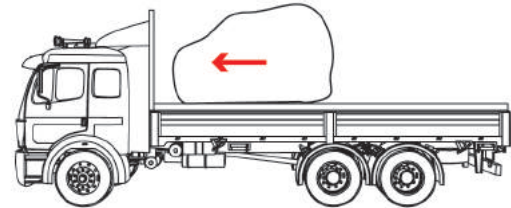

Narrowest end placed toward the front of the vehicle

13. Large Boulders

Tiedown Requirements (Section 3.11.3)

Requirements

- ◆ Use only chain to secure large boulders.



Chain is used to secure large boulders

- ◆ Tiedowns in direct contact with the boulder:
 - Should be located in valleys or notches across the top of the boulder
 - Must be arranged to prevent sliding across the rock surface.

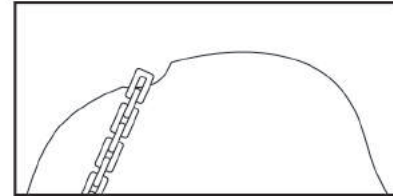

Tiedown is located in notch

13. Large Boulders

Special Circumstances: Securing a Cubic-Shaped Boulder (Section 3.11.3.1)

The securement of a cubic-shaped boulder must meet these requirements in addition to the other large boulder requirements in Section 13.

- ◆ Secure each boulder individually with at least two chain tiedowns placed side-to-side across the vehicle.
- ◆ Place tiedowns as closely as possible to the hardwood blocking used to support the boulder.

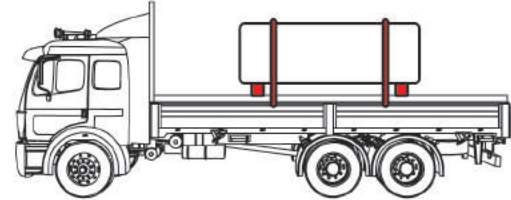

Acceptable securement of a cubic shaped boulder



The aggregate WLL of the tiedowns must be at least 50% the weight of the boulder.

13. Large Boulders

Special Circumstances: Securing a Non-Cubic Shaped Boulder with a Stable Base (Section 3.11.3.2)

The securement of a non-cubic shaped boulder with a stable base must meet these requirements in addition to the other large boulder requirements in Section 13.

- ◆ Secure each boulder individually with at least two chain tiedowns forming an "X" pattern over the boulder.
- ◆ Pass the tiedowns over the center of the boulder and attach them to each other at the intersection by a shackle or other connecting device.

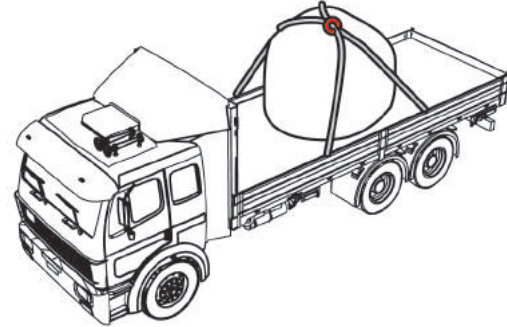

Acceptable securement of a non-cubic Shaped boulder with a stable base



The aggregate WLL of the tiedowns must be at least 50% the weight of the boulder.

13. Large Boulders

Special Circumstances: Securing a Non-Cubic Shaped Boulder with an Unstable Base (3.11.3.3)

The securement of a non-cubic shaped boulder with an unstable base must meet these requirements in addition to the other large boulder requirements in Section 13.

- ◆ Surround the top of each boulder at a point between 1/2 and 2/3 of its height with one chain.



The WLL of the chain must be at least 50% of the weight of the boulder.

- ◆ Attach four chains to the surrounding chain and the vehicle to form a blocking mechanism that prevents any horizontal movement.



Each chain must have a WLL of at least 25% the weight of the boulder.



The angle of the chain must be less than 45° from the horizontal.

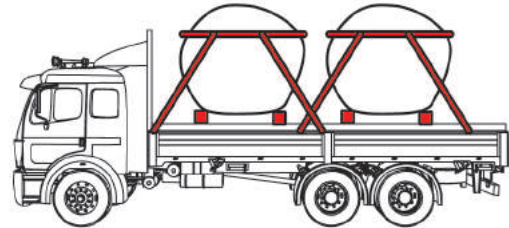

Acceptable securement of a non-cubic Shaped boulder with an unstable base

Appendix A: Default WLLs for Unmarked Tiedowns

Appendix A: Default WLLs for Unmarked Tiedowns

Size	Working Load Limit				
	Grade 30 proof coil	Grade 43 High test	Grade 70 Transport	Grade 80 Alloy	Grade 100 Alloy
7 mm (1/4 in)	580 kg (1300 lb)	1180 kg (2600 lb)	1430 kg (3150 lb)	1570 kg (3500 lb)	1950 kg (4300 lb)
8 mm (5/16 in)	860 kg (1900 lb)	1770 kg (3900 lb)	2130 kg (4700 lb)	2000 kg (4500 lb)	2600 kg (5700 lb)
10 mm (3/8 in)	1200 kg (2650 lb)	2450 kg (5400 lb)	2990 kg (6600 lb)	3200 kg (7100 lb)	4000 kg (8600 lb)
11 mm (7/16 in)	1680 kg (3700 lb)	3270 kg (7200 lb)	3970 kg (8750 lb)	-	-
13 mm (1/2 in)	2030 kg (4500 lb)	4170 kg (9200 lb)	5130 kg (11300 lb)	5440 kg (12000 lb)	6800 kg (15000 lb)
16 mm (5/8 in)	3130 kg (6900 lb)	5910 kg (13000 lb)	7170 kg (15800 lb)	8200 kg (18100 lb)	10300 kg (22600 lb)
Chain Marks					
Example 1	3	4	7	8	10
Example 2	30	40	70	80	100
Example 3	300	400	700	800	1000

Appendix A: Default WLLs for Unmarked Tiedowns

MANILA ROPE	
Diameter	WLL
10 mm (3/8 in)	90 kg (205 lb.)
11 mm (7/16 in)	120 kg (265 lb.)
13 mm (1/2 in)	150 kg (315 lb.)
16 mm (5/8 in)	210 kg (465 lb.)
20 mm (3/4 in)	290 kg (640 lb.)
25 mm (1 in)	480 kg (1050 lb.)

WIRE ROPE (6 x 37, Fiber Core)	
Diameter	WLL
7 mm (1/4 in)	640 kg (1400 lb.)
8 mm (5/16 in)	950 kg (2100 lb.)
10 mm (3/8 in)	1360 kg (3000 lb.)
11 mm (7/16 in)	1860 kg (4100 lb.)
13 mm (1/2 in)	2400 kg (5300 lb.)
16 mm (5/8 in)	3770 kg (8300 lb.)
20 mm (3/4 in)	4940 kg (10900 lb.)
22 mm (7/8 in)	7300 kg (16100 lb.)
25 mm (1 in)	9480 kg (20900 lb.)

Appendix A: Default WLLs for Unmarked Tiedowns

STEEL STRAPPING	
Width-Thickness Inch	WLL
31.7 x 0.74 (1-1/4 x 0.029)	540 kg (1190 lb.)
31.7 x 0.79 (1-1/4 x 0.031)	540 kg (1190 lb.)
31.7 x 0.89 (1-1/4 x 0.035)	540 kg (1190 lb.)
31.7 x 1.12 (1-1/4 x 0.044)	770 kg (1690 lb.)
31.7 x 1.27 (1-1/4 x 0.050)	770 kg (1690 lb.)
31.7 x 1.5 (1-1/4 x 0.057)	870 kg (1925 lb.)
50.8 x 1.12 (2 x 0.044)	1200 kg (2650 lb.)
50.8 x 1.27 (2 x 0.050)	1200 kg (2650 lb.)

SYNTHETIC WEBBING	
Width	WLL
45 mm (1-3/4 in)	790 kg (1750 lb.)
50 mm (2 in)	910 kg (2000 lb.)
75 mm (3 in)	1360 kg (3000 lb.)
100 mm (4 in)	1810 kg (4000 lb.)

POLYPROPYLENE FIBER ROPE (3-STRAND AND 8-STRAND CONSTRUCTIONS)	
Diameter	WLL
10 mm (3/8 in)	180 kg (400 lb.)
11 mm (7/16 in)	240 kg (525 lb.)
13 mm (1/2 in)	280 kg (625 lb.)
16 mm (5/8 in)	420 kg (925 lb.)
20 mm (3/4 in)	580 kg (1275 lb.)
25 mm (1 in)	950 kg (2100 lb.)

POLYESTER FIBER ROPE (3-STRAND AND 8-STRAND CONSTRUCTIONS)	
Diameter	WLL
10 mm (3/8 in)	250 kg (555 lb.)
11 mm (7/16 in)	340 kg (750 lb.)
13 mm (1/2 in)	440 kg (960 lb.)
16 mm (5/8 in)	680 kg (1500 lb.)
20 mm (3/4 in)	850 kg (1880 lb.)
25 mm (1 in)	1500 kg (3300 lb.)

Appendix A: Default WLLs for Unmarked Tiedowns

NYLON ROPE	
Diameter	WLL
10 mm (3/8 in)	130 kg (278 lb.)
11 mm (7/16 in)	190 kg (410 lb.)
13 mm (1/2 in)	240 kg (525 lb.)
16 mm (5/8 in)	420 kg (935 lb.)
20 mm (3/4 in)	640 kg (1420 lb.)
25 mm (1 in)	1140 kg (2520 lb.)

DOUBLE BRAIDED NYLON ROPE	
Diameter	WLL
10 mm (3/8 in)	150 kg (336 lb.)
11 mm (7/16 in)	230 kg (502 lb.)
13 mm (1/2 in)	300 kg (655 lb.)
16 mm (5/8 in)	510 kg (1130 lb.)
20 mm (3/4 in)	830 kg (1840 lb.)
25 mm (1 in)	1470 kg (3250 lb.)

Appendix B: Glossary

Appendix B: Glossary

A	
Aggregate Working Load Limit	The summation of the working load limits or restraining capacity of all devices used to secure an article on a vehicle.
Anchor point	Part of the structure, fitting, or attachment on a vehicle or cargo to which a tiedown is attached.
Article of cargo	A unit of cargo, other than a liquid, gas, or aggregate that lacks physical structure (e.g. grain, gravel, etc.), including articles grouped together so that they can be handled as a single unit or unitized by wrapping, strapping, banding, or edge protection device(s).
B	
Banding	A strip of material that may be used to unitize articles and is tensioned and clamped or crimped back upon itself. (same as "Strapping")
Bell Pipe Concrete	Pipe whose flanged end is of larger diameter than its barrel.
Binder	A device used to tension a tiedown or combination of tiedowns.
Blocking	A structure, device, or another substantial article placed against or around an article to prevent horizontal movement of the article.
Bolster	A transverse load bearing structural component, particularly a part of a log bunk.
Boulder	A large piece of natural rock that may be rounded if it has been exposed to weather and water, or is rough if it has been quarried.
Bracing	A structure, device, or another substantial article placed against an article to prevent it from tipping that may also prevent it from shifting.

Appendix B: Glossary

B	
Bulkhead	A vertical barrier across a vehicle to prevent forward movement of cargo.
Bundle	A group of articles of that has been unitized for securement as a single article.
Bunk	A horizontal bolster fitted with a stake at each end that together support and contains a stack of logs, and is installed transversely
C	
Cab shield	A vertical barrier placed directly behind the cab of a tractor to protect the cab in the event cargo should shift forward.
Cargo	All articles or material carried by a vehicle, including those used in operation of the vehicle.
Chock	A tapered or wedge-shaped piece used to secure round articles against rolling.
Cleat	A short piece of material, usually wood, nailed to the deck to reinforce blocking.
Coil bunk	A device that keeps timbers supporting a metal coil in place.
Contained	Cargo is contained if it fills a sided vehicle, and every article is in contact with or sufficiently close to a wall or other articles so that it cannot shift or tip if those other articles are also unable to shift or tip.
Container Chassis Vehicle	A vehicle especially built and fitted with locking devices for the transport of intermodal containers.
Cradle	A device or structure that holds a circular article to prevent it from rolling.

Appendix B: Glossary

C	
Crosswise	Same as “Lateral”
Crown	The rounded profile of the top of a stack of logs, when viewed from the ends of the stack.
Cut-to-length logs	Included in shortwood.
D	
Deck	The load carrying area of a truck, trailer, or intermodal container.
Direct tiedown	A tiedown that is intended to provide direct resistance to potential shift of an article.
Direct tiedown	All loose materials used to support and protect cargo.
Dunnage bag	An inflatable bag intended to fill otherwise empty space between articles of cargo, or between articles of cargo and the wall of the vehicle.
E	
Edge protector	A device placed on the exposed edge of an article to distribute tiedown forces over a larger area of cargo than the tiedown itself, to protect the tie-down and/or cargo from damage, and to allow the tiedown to slide freely when being tensioned.
Eye (of a cylindrical object)	The hole through the centre of the article.

Appendix B: Glossary

F	
Flatbed vehicle	A vehicle with a deck but no permanent sides.
Frame vehicle	A vehicle with skeletal structure fitted with one or more bunk units for transporting logs. A bunk unit consists of a front bunk and a rear bunk that together cradle logs. The bunks are welded, gusseted, or otherwise firmly fastened to the vehicle's main beams, and are an integral part of the vehicle.
Friction mat	A device placed between the deck of a vehicle and car or between articles of cargo, intended to provide greater friction than exists naturally between these surfaces.
G	
g	The acceleration due to gravity, 9.823 m/sec ² (32.2 ft/sec ²).
Gross Combination Weight Rating	The value specified for the vehicle by the "Manufacturer" as being the maximum of the sum of the "Gross Vehicle Mass" of the drawing vehicle plus the sum of the "Axle Loads" of all vehicles being drawn.
Gross Vehicle Weight Rating	The maximum laden weight of a motor vehicle as specified by the "Manufacturer."
H	
Headboard	A vertical barrier across the front of the deck of a vehicle to prevent forward movement of cargo.
Hook-lift Container	A specialized container, primarily used to contain and transport materials in the waste, recycling, construction/ demolition, and scrap industries, which are used in conjunction with specialized vehicles, in which the container is loaded and unloaded onto a tilt frame body by an articulating hook-arm.

Appendix B: Glossary

I	
Indirect tiedown	A tiedown whose tension is intended to increase the pressure of an article or stack of articles on the deck of the vehicle.
Integral Locking Device	A device that is purposely designed and used to restrain an article of cargo on a vehicle by connecting and locking attachment point(s) on the article to anchor point(s) on the vehicle.
Integral Securement System	A feature of roll-on/roll-off containers and hook-lift containers and their related transport vehicles in which compatible front and rear hold down devices are mated to provide securement of the complete vehicle and its cargo
Intermodal Container	A reusable, transportable enclosure that is especially designed with integral locking devices that secure it to a container chassis trailer to facilitate the efficient and bulk shipping and transfer of goods by, or between various modes of transport, such as highway, rail, sea, and air.
J	
K	
L	
Lateral	Sideways, transverse, crosswise, or across a vehicle.
Lengthwise	Same as "Longitudinal"
Lift	A tier of dressed timber, steel, or other materials.
Load binder	A binder incorporating an over-centre locking action.

Appendix B: Glossary

L	
Load capacity	The weight of cargo that a vehicle can carry when loaded to its allowable gross vehicle weight in a particular jurisdiction.
Logs	Include all natural wood that retains the original shape of the bole of the tree, whether raw, partially, or fully processed. Raw logs include all tree species with bark that have been harvested and may have been trimmed or cut to some length. Partially processed logs that have been fully or partially debarked or further reduced in length. Fully processed logs include utility poles, treated poles, and log cabin building components.
Longitudinal	Lengthwise or along the length of a vehicle.
Longwood	All logs that are not shortwood and are over 4.9 m (16 feet) long. Such logs are usually described as long logs or treelength.
M	
N	
O	
P	
Pallet	A platform or tray on which cargo is placed so that it can be handled as an article. (Same as "Skid")
Pole Trailer	A trailer whose body consists simply of a drawbar by which the trailer is drawn.
Q	

Appendix B: Glossary

R	
Rail vehicle	A vehicle whose skeletal structure is fitted with stakes at the front and rear to contain logs loaded crosswise.
Restrained	An article that is not contained, but is prevented from tipping or shifting.
Rub Rail	A rail along the side of a vehicle that protects the side of the vehicle from impacts.
S	
Secured	Means by which cargo is contained or restrained.
Securing Device	Any device specifically manufactured as a means to attach or secure cargo to a vehicle or trailer.
Shackle	A U-shaped metal coupling link closed by a bolt.
Shift	A change in the longitudinal or lateral position or orientation of an article.
Shoring bar	A structural section placed transversely between the walls of a vehicle to prevent cargo from tipping or shifting.
Shortwood	All logs typically up to 4.9 m (16 feet) long. Such logs are often described as cut-up logs, cut-to-length logs, bolts, or pulpwood. Shortwood may be loaded lengthwise or crosswise, though that loaded crosswise is usually no more than 2.6 m (102 inches) long.
Sided Vehicle	A vehicle whose cargo compartment is enclosed on all four sides by walls of sufficient strength to contain cargo, where the walls may include latched openings for loading and unloading, and includes vans and dump bodies, and includes a sided intermodal container carried by a vehicle.
Skid	A platform or tray on which cargo is placed so that it can be handled as an article. (Same as "Pallet")
Spacer	Material placed beneath an article or between tiers of articles to

Appendix B: Glossary

R	
Stack	A single column of articles placed one above another.
Stack of logs	Logs aligned parallel and heaped one upon others.
Stake	A member mounted close to vertical on a vehicle frame or as part of a bunk that serves to immobilize cargo placed against it. (Same as "Standard")
Stake Pocket	A female housing fixed to the side or ends of a vehicle to receive a stake or peg, and may also be used as an anchor point.
Standard	A member mounted close to vertical on a vehicle frame or as part of a bunk that serves to immobilize cargo placed against it. (Same as "Stake")
Strapping	A strip of material that may be used to unitize articles and is tensioned and clamped or crimped back upon itself. (Same as "Banding")
T	
Tarpaulin (tarp)	A waterproof sheet used to cover cargo.
Tiedown	A combination of securing devices which form an assembly that attaches cargo to, or restrains cargo on, a vehicle or trailer, and is attached to anchor point(s).
Tiedown assembly	(Same as "Tiedown").
Tier	One layer of articles that are stacked one upon another.
Tip	An article falls over.
Track	A set of plates on a tractor wheel that provide mobility for a tracked vehicle.

Appendix B: Glossary

T	
Tractor-pole trailer	A vehicle that carries logs lengthwise so that they form the body of the vehicle. The logs are supported by a bunk located on the rear of the tractor and another bunk on the skeletal trailer. The bunks may rotate about a vertical axis, and the trailer may have a fixed, scoping, or cabled reach, or other mechanical freedom, to allow it to turn.
Transverse	(Same as “Lateral”)
Twist lock	A device designed to support and fasten one corner of an intermodal container to a container chassis vehicle.
U	
Unitized load	A number of articles grouped together with sufficient structural integrity that they can be handled, transported and secured as a single article.
V	
Vehicle	A truck, truck tractor, trailer, or semitrailer individually or in combination.
Void Filler	Material used to fill a void between articles of cargo and the structure of the vehicle that has sufficient strength to prevent movement of the articles of cargo.
W	
Wedge	A tapered piece of material, thick at one end and thin at the other.
Well	The depression formed between two cylindrical articles when they are laid with their eyes horizontal and parallel against each other.
Winch	A device for tensioning a webbing or wire rope tiedown that is fitted with means to lock the initial tension.

Appendix B: Glossary

W	
Working Load Limit (WLL)	The maximum load that may be applied to a component of a cargo securement system during normal service, usually assigned by the manufacturer of the component.
X	
Y	
Z	